



## DIRECT VENT GAS

FIREPLACE DESIGN COLLECTION



*FRONT COVER: Scorpio with shown with  
Old Town Red Herringbone Ceramic Fiber Liners*

astria  
FIREPLACES®

To see more of our product offerings and specifications, visit [Astria.us.com](http://Astria.us.com).

astria  
FIREPLACES®

*Let your style shine.*



When you enter your favorite room, you are transformed. You become inspired and relaxed all at once. Enchanted and completely at home. Every carefully placed detail is a reflection of your style — a reflection of your story.

We understand. The remarkable craftsmanship found within the Astria® fireplace collection is of the utmost importance to us — because we know it means everything to you. We understand that form and function should only exist in harmony. And that the little things are just as important as the big things.

So, whether you're looking for the missing piece or a fresh start, may the perfect finishing touch find you here.

*astria*  
FIREPLACES®  
*Let your style shine.*









STANDARD



FEATURED Aries shown with Oak Log Set

## ARIES

The Aries Traditional direct vent combines beauty, efficiency and value, and features a clean faced heat-circulating design with beautiful flame, glowing embers and detailed 5-piece ceramic fiber oak logs. All models are equipped with a standard barrier that meets 2015 requirements. Available in a dedicated top or rear flue configuration. Standard black painted interior. Ignition systems available in either millivolt or energy saving electronic ignition with seamless battery back-up. Built-in barrier for added safety.

-   
**FLAME**
-   
**DETAILED LOGS**
-   
**SEAMLESS BATTERY BACKUP**
-   
**2015 ANSI COMPLIANT BARRIER**
-   
**TEMPERED GLASS**
-   
**IPI CPI SWITCH**
-   
**BLOWER**
-   
**LINER**
-   
**REMOTE**

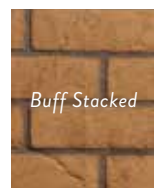
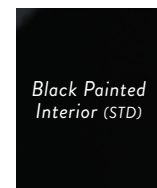

Choose from two distinctive liners.



LINERS









DELUXE



FEATURED Gemini shown with Oak Log Set and Buff Stacked Ceramic Fiber Liners

## GEMINI

The newly designed Gemini™ series of direct-vent gas fireplaces projects versatile style and performance. Outfitted with inviting features and outstanding performance, these fireplace units also feature a number of optional accessories, allowing a personal, customized touch. The units are built with quality components and are easy to install. That's the essence of the new Astria Gemini™ series.

-   
**BIG FLAME**
-   
**HIGHLY DETAILED LOGS**
-   
**SEAMLESS BATTERY BACKUP**
-   
**2015 ANSI COMPLIANT BARRIER**
-   
**TEMPERED GLASS**
-   
**IPI CPI SWITCH**
-   
**BLOWER**
-   
**LINER**
-   
**REMOTE**

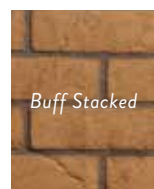

Choose from three distinctive ceramic fiber liner kits.



LINERS

PREMIUM



FEATURED Scorpio shown with Oak Log Set and Old Town Red Herringbone Ceramic Fiber Liners

## SCORPIO

The superbly designed Scorpio Series Direct Vent Gas Fireplaces are the embodiment of traditional style and performance. Dressed with an array of standard features, such as ceramic glass, factory-installed blower, full-function remote control, interior illumination and industry-leading AFUE ratings, these fireplaces are the perfect centerpiece for any room. Tradition. Style. Performance. That's the essence of the new Astria Scorpio Series Direct Vent Gas Fireplaces.

-   
**BIGGER FLAME**
-   
**HIGHLY DETAILED LOGS**
-   
**SEAMLESS BATTERY BACKUP**
-   
**INTERIOR LIGHTING**
-   
**2015 ANSI COMPLIANT BARRIER**
-   
**CERAMIC GLASS**
-   
**BLOWER**
-   
**LINER REQUIRED OPTION**



Choose from four distinctive liners.

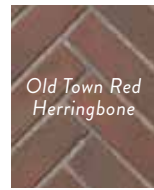







LINERS



Full-function deluxe ProFlame II Remote Included

# ARIES CD

The Aries Traditional direct vent combines beauty, efficiency and value, and features a clean faced heat-circulating design with beautiful flame, glowing embers and detailed 5-piece ceramic fiber oak logs. All models are equipped with a standard barrier that meets 2015 requirements. Available in a dedicated top or rear flue configuration. Standard black painted interior. Ignition systems available in either millivolt or energy saving electronic ignition with seamless battery back-up. Built-in barrier for added safety.

-   
**FLAME**
-   
**SEAMLESS BATTERY BACKUP**
-   
**2015 ANSI COMPLIANT BARRIER**
-   
**TEMPERED GLASS**
-   
**IPI CPI SWITCH**
-   
**BLOWER**
-   
**REMOTE**



Crushed glass media in a variety of colors.



MEDIA

INTERIOR









FEATURED: Aries CD 35 shown with standard Reflective Black Crushed Glass Media

STANDARD

# GEMINI CD

The awe-inspiring Gemini CD Series direct vent gas fireplace is truly one for the modern age. Fashioned with an elegant two-piece façade, porcelain liners, and crushed glass media, the Gemini CD standard features represent magnificent simplicity. Optional features like high-definition driftwood logs and tumbled river stones punctuate its contemporary appeal. The Gemini CD is modern sophistication at its finest.

-   
**BIG FLAME**
-   
**SEAMLESS BATTERY BACKUP**
-   
**2015 ANSI COMPLIANT BARRIER**
-   
**TEMPERED GLASS**
-   
**IPI CPI SWITCH**
-   
**BLOWER**
-   
**REMOTE**



Crushed glass media in a variety of colors.

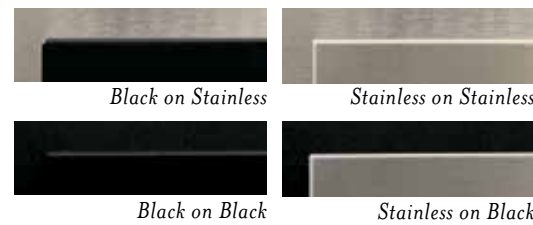

OPTIONS



MEDIA

SURROUNDS

INTERIOR









FEATURED: Gemini CD 35 shown with Reflective Black Crushed Glass Media

DELUXE

# SCORPIO CD

The masterfully designed Scorpio™ CD series is the essence of sophisticated contemporary style. Fashioned with elegant standard features such as reflective porcelain interiors, interior lighting and high performance ratings, these fireplace units are available in three sizes to fit any room. The new Astria Scorpio™ CD is the quintessential combination of brawn and beauty.

-   
**BIGGER FLAME**
-   
**SEAMLESS BATTERY BACKUP**
-   
**INTERIOR LIGHTING**
-   
**2015 ANSI COMPLIANT BARRIER**
-   
**CERAMIC GLASS**
-   
**BLOWER**

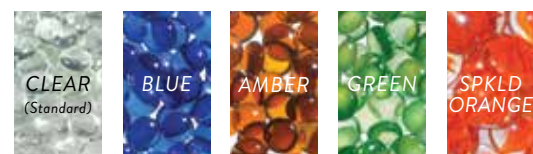

Glass pebble media in a variety of colors.



Full-function deluxe ProFlame II Remote Included



MEDIA

INTERIOR



FEATURED: Scorpio CD 35 shown with Clear Glass Pebble Media

PREMIUM

**FIREPLACE EFFICIENCIES** – Listed to ANSI Z21.88 as a gas fireplace heater.

MODEL	FUEL	BTU/HR	AFUE**	P4 / ENERGUIDE*
ARIES / ARIES CD 33	NG	12,000	64%	60.4%/64.8%
ARIES / ARIES CD 33	LP	10,000	64%	60.4%/64.8%
ARIES / ARIES CD 35	NG	14,000	65.5%	61.0%/65.0%
ARIES / ARIES CD 35	LP	12,000	65.5%	61.0%/65.0%
ARIES / ARIES CD 40	NG	16,000	65.5%	62.0%/65.0%
ARIES / ARIES CD 40	LP	15,000	65.5%	62.0%/65.0%
ARIES / ARIES CD 45	NG	20,000	65%	63.0%/66.0%
ARIES / ARIES CD 45	LP	19,000	65%	63.0%/66.0%

**FIREPLACE EFFICIENCIES** – Listed to ANSI Z21.88 as a gas fireplace heater.

MODEL	FUEL	BTU/HR	AFUE**	P4 / ENERGUIDE*
GEMINI 33	NG	14,000	65%	60.0% / 63.0%
GEMINI 33	LP	13,000	65%	60.0% / 63.0%
GEMINI 35	NG	16,000	66%	61.0% / 63.0%
GEMINI 35	LP	15,000	66%	61.0% / 63.0%
GEMINI 40	NG	20,000	66%	61.0% / 63.0%
GEMINI 40	LP	19,000	66%	61.0% / 63.0%
GEMINI 45	NG	21,500	67%	61.0% / 63.0%
GEMINI 45	LP	21,500	67%	61.0% / 63.0%

**FIREPLACE EFFICIENCIES** – Listed to ANSI Z21.88 as a gas fireplace heater.

MODEL	FUEL	BTU/HR	AFUE**	P4 / ENERGUIDE*
GEMINI CD 35	NG	16,000	66%	63.0%
GEMINI CD 35	LP	15,000	66%	63.0%
GEMINI CD 40	NG	20,000	66%	63.0%
GEMINI CD 40	LP	19,000	66%	63.0%

**FIREPLACE EFFICIENCIES** – Listed to ANSI Z21.88 as a gas fireplace heater.

MODEL	FUEL	BTU/HR	AFUE**	P4 / ENERGUIDE*
SCORPIO / SCORPIO CD 35	NG	20,000	70%	64.0%
SCORPIO / SCORPIO CD 35	LP	19,000	70%	64.0%
SCORPIO / SCORPIO CD 40	NG	24,000	70%	64.0%
SCORPIO / SCORPIO CD 40	LP	22,000	70%	64.0%
SCORPIO / SCORPIO CD 45	NG	28,000	71%	65.0%
SCORPIO / SCORPIO CD 45	LP	26,000	71%	65.0%

\*Intermittent ignition systems.

\*\*Annual Fuel Utilization Efficiency (AFUE) is the recognized U.S. rating system for the total efficiency of heating products.

**ALL MODELS FEATURED HAVE THE SAME FRAMING SPECIFICATIONS.**

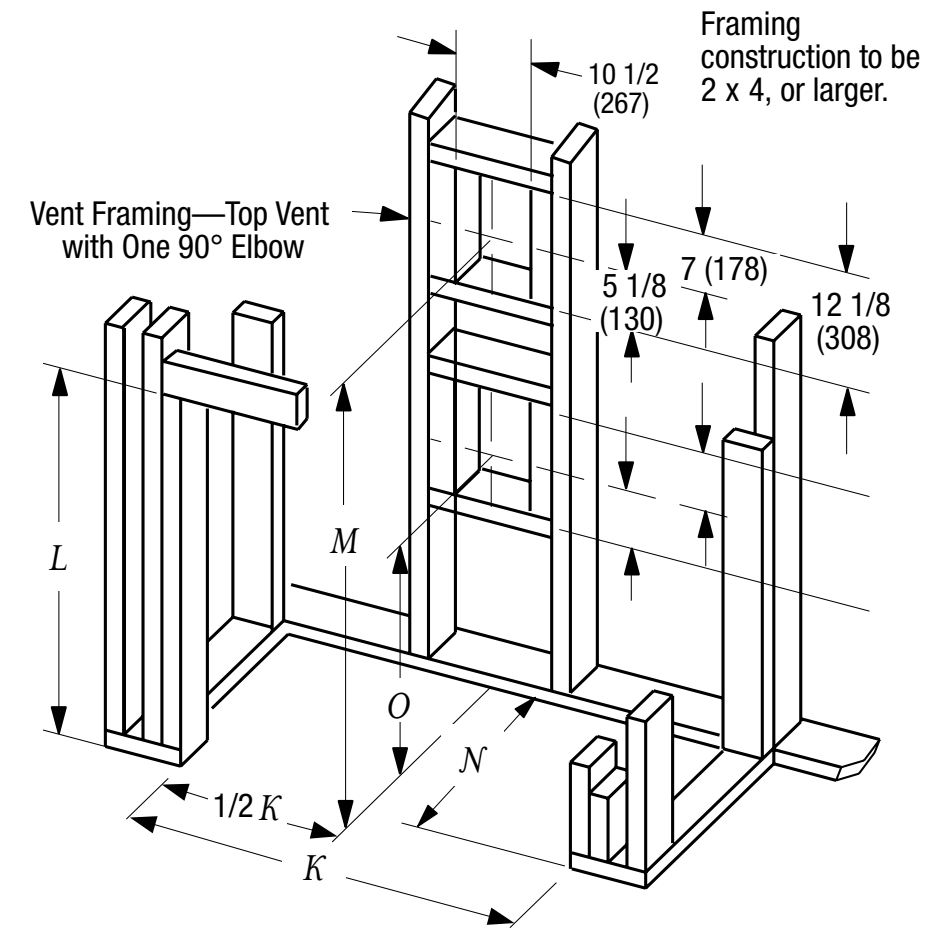

	33" MODEL**	35" MODEL	40" MODEL	45" MODEL
<b>K</b>	33-3/4"	35-3/8"	40-3/8"	45-3/8"
<b>L</b>	34-1/4"*	36-1/4"*	41-1/4"*	41-1/4"*
<b>M</b>	36-7/8"	38-3/4"	43-3/4"	43-3/4"
<b>N</b>	14-1/2"	18"	18"	18"
<b>O</b>	19-5/8"	23-3/8"	28-1/4"	28-1/4"

\* Includes 4" for fold-up standoffs

\*\* (ARIES & GEMINI ONLY)

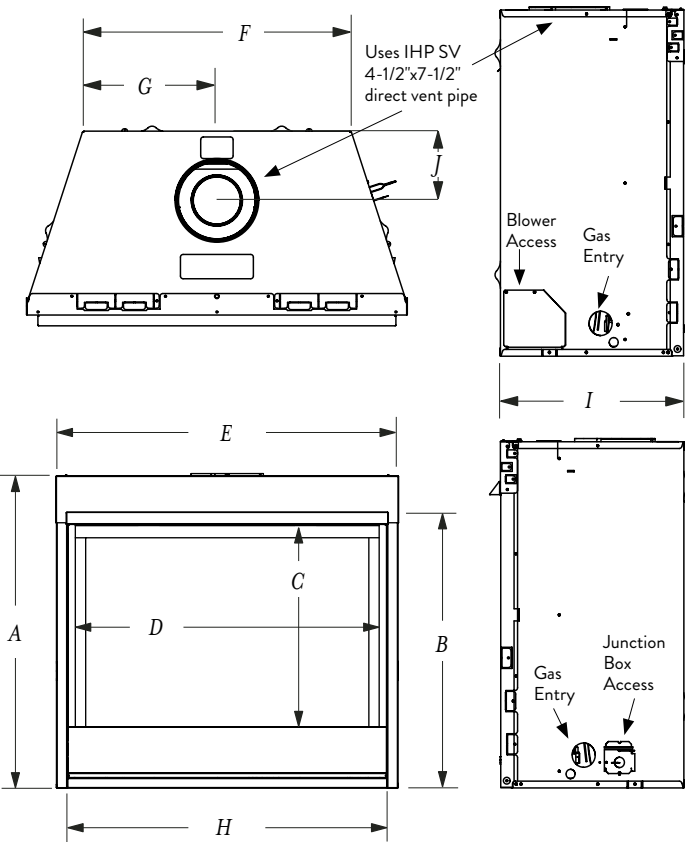

	33" MODEL**	35" MODEL	40" MODEL	45" MODEL
<b>A</b>	30-1/8"	32-1/8"	37-1/8"	37-1/8"
<b>B</b>	26-1/4"	28-3/4"	33-1/4"	33-1/4"
<b>C</b>	18-5/16"	22-1/4"	27-1/4"	27-1/4"
<b>D</b>	30-1/2"	32-3/8"	37-3/8"	42-3/8"
<b>E</b>	33-5/8"	35-1/4"	40-1/4"	45-1/4"
<b>F</b>	21-7/8"	25"	30"	35"
<b>G</b>	10-15/16"	12-1/2"	15"	17-1/2"
<b>H</b>	31"	32-7/8"	37-7/8"	42-7/8"
<b>I</b>	14"	17"	17"	17"
<b>J</b>	5-3/4"	6-7/8"	6-7/8"	6-7/8"

\*\* (ARIES & GEMINI ONLY)

\* Includes 4" for fold-up standoffs

**IMPORTANT NOTES:**

As with any fireplace, this appliance is extremely hot during operation. Read and understand all operating instructions before using this appliance. For further information, consult your dealer.

Local conditions, such as elevation, wind, vent configuration and choice of fuel will affect overall appearance of the fire and heating performance. Performance can also vary with home design and insulation, climate, condition and type of fuel used, appliance location, burn rate, accessories chosen, chimney installation and how the appliance is operated.

Diagrams, illustrations and photographs are not to scale—consult installation instructions. Product designs, materials, dimensions, specifications, colors and prices are subject to change or discontinuance without notice.