

 AMERIVENT®



D I R E C T V E N T



AMERICAN METAL®
PRODUCTS GROUP

Edition 3

Direct Vent

Table of Contents

Introduction	1
Product Description	1
Specifications and Dimensions	2
Pipe Section	3
Adjustable Length	3
45° Elbow	3
90° Elbow	3
Vertical Cap	4
Horizontal Cap, Round	4
Horizontal Cap, Square	4
Vinyl Siding Shield	4
Wind/Screen Cover	5
Snorkel Cap	5
Homestyle™ Collection Direct Vent Caps	5
Wall Thimble	6
Wall Strap	6
Firestop Support Plate	6
Face Plate, Ceiling Support/Wall Thimble	6
Cathedral Ceiling Support	7
Storm Collar	7
Flashings	7
Attic Insulation Shield	7
Collinear Connectors	8
Homestyle™ Collection Collinear Direct Vent Caps	9-11
Flexible Vent Pipe	12
Chimney Conversion Kits	12
Termination Kits	13
Adapters	14
Typical AmeriVent Direct Vent Installations	15
45° Elbow Pipe Offsets	16

A full line of the finest products is yours from American Metal Products.

AmeriVent All-Fuel Chimney - Model HS/HSS
 All-Fuel Chimney - Model TLC
 Black Stovepipe
 Direct Vent
 Model CV Special Gas Vent
 Model SW Special Gas Vent
 Pellet Pipe Plus - Model PVP
 Pellet Vent
 Type B Gas Vent

AmeriFlex Flexible Duct Systems

J&J Register Light Commercial Grilles, Registers & Diffusers
 Duct System Components

Lima Register Residential Grilles, Registers & Diffusers

Introduction

AmeriVent Direct Vent is manufactured by American Metal Products, a pioneer in the development and simplification of effective venting products since 1951. Designed for the venting of direct vent hearth appliances, AmeriVent Direct Vent is the preferred, most efficient, economical, and easily installed direct venting system in the industry.

Patent No. 6,634,352

Product Description

AmeriVent Direct Vent provides a complete line of components for all typical installations, both vertical and horizontal. The factory-assembled construction of AmeriVent Direct Vent is unique, having a galvanized steel outer wall and superior corrosion-resistant stainless steel inner wall. AmeriVent Direct Vent fits most existing start collars.

The inner-wall, factory-installed graphite gasket makes for easy, secure twist-lock installation. The 360° rotation allows elbows and straight pipe to rotate in either direction, while still maintaining the secure lock system.

For a complete listing of AmeriVent Direct Vent certified appliances, contact Customer Service at **800-423-4270**, or visit our web site at **www.americanmetalproducts.com**.

AmeriVent Direct Vent and all fine products manufactured by American Metal Products are shipped from distribution points in Huntsville, Alabama, and Mira Loma, California.

Specifications and Dimensions

Available Pipe Sizes and Lengths

Sizes: Nominal 4" ID x 6⁵/₈" OD and
Nominal 5" ID x 8" OD

Lengths: 7", 12", 24", 36", and 48"

Usage

For venting direct vent gas appliances listed or certified for use with AmeriVent Direct Vent. For information on venting gas appliances having draft hoods and other appliances listed to be used with Type B Gas Vent, request our Type B Gas Vent Catalog. For information on venting unlisted gas appliances or appliances burning solid or liquid fuels, request our TLC Chimney Catalog.

Material

Inner Pipe: Type 430 Stainless Steel

Outer Pipe: Galvanized Steel

Metal Thickness

Pipe Size	Inner Pipe	Outer Pipe
Nominal 4" x 6 ⁵ / ₈ "	.012"	.018"
Nominal 5" x 8"	.012"	.018"

Clearances

Refer to the appliance manufacturer's installation instructions for minimum clearances to combustibles.

Fitting and Accessories

- 90° Elbow
- 45° Elbow (offset)
- Adjustable Length Pipe
- Storm Collar
- Wall Thimble
- Firestop Support Plate
- Attic Insulation Shield
- Face Plate
- Cathedral Ceiling Support
- Flashing - Standard
- Flashing - Steep Pitch
- Wall Strap
- Vertical Cap
- Horizontal Cap
- Snorkel Cap
- Collinear Appliance Adapter
- Collinear Top Kit

Listed by

- CSA
- ITS
- Omni
- UL

How to Specify

Direct vent systems shall be listed with AmeriVent Direct Vent or equal. Systems shall be installed in accordance with terms of the vent listing and the appliance manufacturer's instructions.

Pipe Section

Lengths: 7", 12", 24", 36", and 48"
Sizes: 4" x 6⁵/₈" and 5" x 8"



AmeriVent Direct Vent Pipe features rugged, co-axial tube construction with a stainless steel inner wall and a galvanized steel outer wall, separated by two spacers. Twist-lock joints offer fast installations. Factory-installed inner gasket ensures a leak-free joint. Also available in a painted black finish. To order painted black finish, add B to product Part No. (ex. 4D7B).

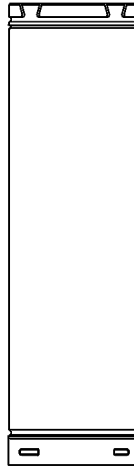

Part No.	Length	Size	ID	OD
4D7	7"	4" x 6 ⁵ / ₈ "	4"	6 ⁵ / ₈ "
4D12	12"	4" x 6 ⁵ / ₈ "	4"	6 ⁵ / ₈ "
4D24	24"	4" x 6 ⁵ / ₈ "	4"	6 ⁵ / ₈ "
4D36	36"	4" x 6 ⁵ / ₈ "	4"	6 ⁵ / ₈ "
4D48	48"	4" x 6 ⁵ / ₈ "	4"	6 ⁵ / ₈ "
5D7	7"	5" x 8"	5"	8"
5D12	12"	5" x 8"	5"	8"
5D24	24"	5" x 8"	5"	8"
5D36	36"	5" x 8"	5"	8"
5D48	48"	5" x 8"	5"	8"

Adjustable Length



Telescopes onto standard pipe sections for adjustments from 3" to 5" for 7A's, 3" to 10" for 12A's, 3" to 14" for 16A's, and 3" to 24" for 26A's. Includes stainless steel self-tapping screws. Also available in a painted black finish. To order painted black finish, add B to product Part No. (ex. 4D12AB).

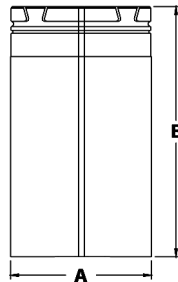

Part No.	Size	A	B
4D7A	4" x 6 ⁵ / ₈ "	6 ¹¹ / ₁₆ "	7"
4D12A	4" x 6 ⁵ / ₈ "	6 ¹¹ / ₁₆ "	12"
4D16A	4" x 6 ⁵ / ₈ "	6 ¹¹ / ₁₆ "	16"
4D26A	4" x 6 ⁵ / ₈ "	6 ¹¹ / ₁₆ "	26"
5D7A	5" x 8"	8 ¹ / ₈ "	7"
5D12A	5" x 8"	8 ¹ / ₈ "	12"
5D16A	5" x 8"	8 ¹ / ₈ "	16"
5D26A	5" x 8"	8 ¹ / ₈ "	26"

45° Elbow



Use with 45° fireplace adapters or in pairs to go around obstructions. Add pipe sections between elbows for additional offset. Also available in a painted black finish. To order painted black finish, add B to product Part No. (ex. 4D45LB).

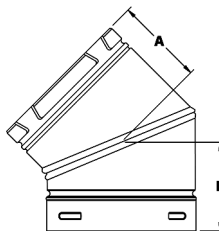

Part No.	Size	A	B
4D45L	4" x 6 ⁵ / ₈ "	4 ¹ / ₂ "	4 ¹ / ₂ "
5D45L	5" x 8"	4 ³ / ₄ "	4 ³ / ₄ "

See 45° Elbow Pipe Offsets chart on page 16.

90° Elbow



Three-section design provides smooth, low-resistant 90° offset. Also available in a painted black finish. To order painted black finish, add B to product Part No. (ex. 4D90LB).

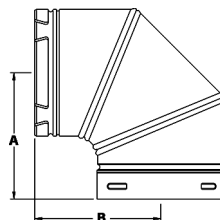

Part No.	Size	A	B
4D90L	4" x 6 ⁵ / ₈ "	6 ¹¹ / ₁₆ "	6 ⁹ / ₁₆ "
5D90L	5" x 8"	7 ¹ / ₂ "	7 ⁵ / ₃₂ "

Vertical Cap



Use for vertical venting applications. Corrosion-resistant construction with stainless steel inner wall. Low-restriction design improves efficiency.

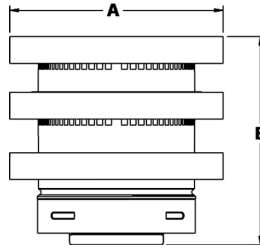

Part No.	Size	A	B
4DVC	4" x 6 ⁵ / ₈ "	9 ¹ / ₄ "	9"
5DVC	5" x 8"	11 ¹ / ₄ "	9 ¹ / ₂ "

Horizontal Cap, Round

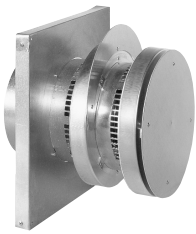

Use for horizontal venting applications. Corrosion-resistant construction with stainless steel inner wall. Low-restriction design improves efficiency and minimizes wall temperature. Cap shown with the vinyl siding shield attached. Shield included in box, unattached.

Part No.	Size	A	B	C	D
4DHC	4" x 6 ⁵ / ₈ "	11"	8"	9 ¹ / ₄ "	12"
5DHC	5" x 8"	13"	8 ¹ / ₂ "	11"	14 ¹ / ₄ "

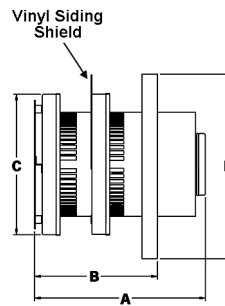

Horizontal Cap, Square



For use with horizontal, through-the-wall venting systems. Sleek, low-profile design. Vinyl Siding Shield sold separately.

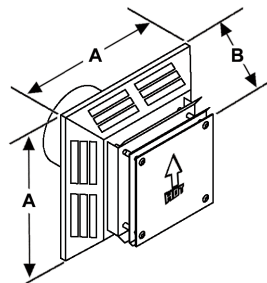

Part No.	Size	A	B
4DHCS	4" x 6 ⁵ / ₈ "	13 ¹ / ₂ "	7"
5DHCS	5" x 8"	16"	7"

Vinyl Siding Shield

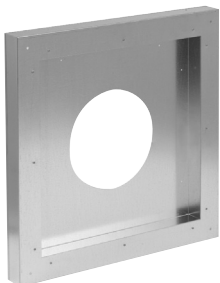

For use **ONLY** with Square Horizontal Cap.

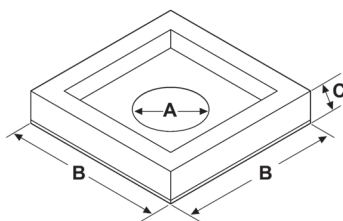

Part No.	Size	A	B	C
4DHVS	4" x 6 ⁵ / ₈ "	6 ⁵ / ₈ "	17 ³ / ₈ "	2"
5DHVS	5" x 8"	8 ¹ / ₄ "	19 ⁷ / ₈ "	2"

Wind Screen/Cover

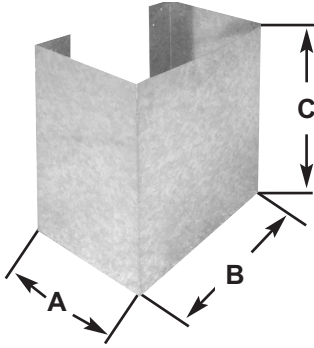

Part No.	A	B	C
4DHWS	9"	13 ¹ / ₄ "	14 ³ / ₄ "

The cover provides a wind screen for homes in high wind areas. It shields and hides horizontal caps, providing added heat protection for children and pets. No new holes to drill; the cover uses existing cap screws and holes in the base. One cover works with both 4" and 5" horizontal caps. These covers can also be used on snorkel caps. The sturdy, galvanized steel cover can be painted to match the exterior color of the home. Not listed.

Snorkel Cap

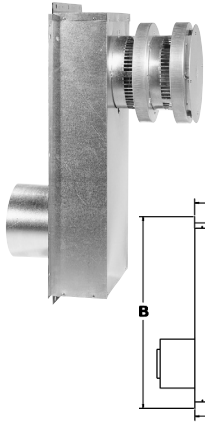

Use for horizontal vent installations that require a vertical rise on the exterior of the building. Corrosion-resistant construction with stainless steel inner wall. Low-restriction design improves efficiency and minimizes wall temperature.

Part No.	Size	A	B	C	D	E	F
4D14S	4" x 6 ⁵ / ₈ "	12"	26 ¹ / ₂ "	4 ³ / ₄ "	12 ¹ / ₂ "	14"	6 ¹ / ₄ "
4D36S	4" x 6 ⁵ / ₈ "	12"	48 ¹ / ₂ "	4 ³ / ₄ "	12 ¹ / ₂ "	36"	6 ¹ / ₄ "
5D14S	5" x 8"	14 ¹ / ₂ "	26 ¹ / ₂ "	6 ¹ / ₂ "	14 ¹ / ₄ "	14"	6 ¹ / ₄ "
5D36S	5" x 8"	14 ¹ / ₂ "	48"	6 ¹ / ₂ "	14 ¹ / ₄ "	36"	6 ¹ / ₄ "

Homestyle™ Collection Direct Vent Caps

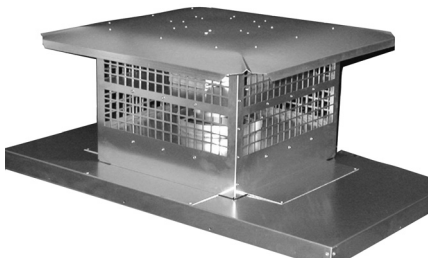

These stylish direct vent caps enhance the look of any home. Available in aluminum, black-powder coated, black with terra-cotta Real Flue™, and solid copper.

Chase cover-mounted shown
(by others)

Part No.	Finish	Size	Body Style	Vent Style
4DH-1313	Aluminum	13" x 13" Body	Chase Mount Bottom	4" Vent & 6 ⁵ / ₈ " Intake
4DH-1313-B	Black Powder-Coated	13" x 13" Body	Chase Mount Bottom	4" Vent & 6 ⁵ / ₈ " Intake
4DH-1313-BR	Black/Terra Cotta	13" x 13" Body	Chase Mount Bottom	4" Vent & 6 ⁵ / ₈ " Intake
4DH-1313-C	Solid Copper	13" x 13" Body	Chase Mount Bottom	4" Vent & 6 ⁵ / ₈ " Intake
5DH-1313	Aluminum	13" x 13" Body	Chase Mount Bottom	5" Vent & 8" Intake
5DH-1313-B	Black Powder-Coated	13" x 13" Body	Chase Mount Bottom	5" Vent & 8" Intake
5DH-1313BR	Black/Terra Cotta	13" x 13" Body	Chase Mount Bottom	5" Vent & 8" Intake
5DH-1313-C	Solid Copper	13" x 13" Body	Chase Mount Bottom	5" Vent & 8" Intake

Homestyle™ and Real Flue™ are trademarks of RLH Industries, Inc.

Wall Thimble



Provides clearance and fire-stopping for through-the-wall installations. Can be used with a black painted Face Plate for the interior wall. Adjustable from 4½" to 8½".

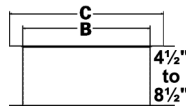
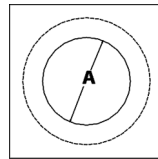

Part No.	A	B	C
4DWT	6¾"	10"	11 ¹¹ / ₁₆ "
5DWT	8¼"	11½"	14"

Wall Strap



Provides lateral support for vent and offsets, while maintaining clearance from the wall.

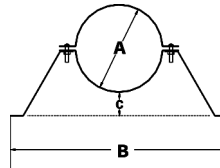

Part No.	A	B	C
4DWS	6 ⁵ / ₈ "	15½"	2"
5DWS	8"	18"	2"

Firestop Support Plate



Provides vertical support for vent and offsets, while maintaining clearance from the wall and providing a firestop. Can be used with the black painted Face Plate for the interior ceiling.

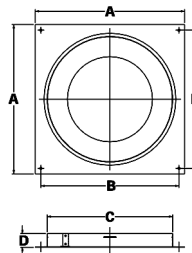

Part No.	A	B	C	D
4DFSP	12"	11"	10"	1"
5DFSP	14"	13"	11"	1"

Face Plate

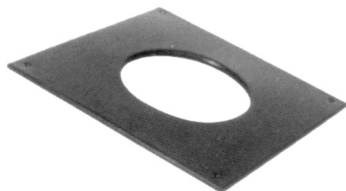

Use as a decorative cover for the Firestop Support Plate or Wall Thimble. Black painted surface for interior wall.

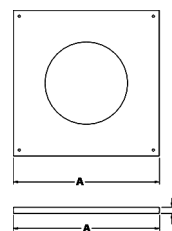

Part No.	A	B
4DFPB	12"	½"
5DFPB	14¼"	½"

Cathedral Ceiling Support



Use as support and firestop in cathedral ceiling installations. Cathedral Ceiling Support Trim Plate is a decorative trim used to conceal rough opening where Cathedral Ceiling Support passes through ceiling. Fits from flat to 12/12 pitch ceilings. Cathedral Ceiling Support and Cathedral Ceiling Support Trim Plate painted black.

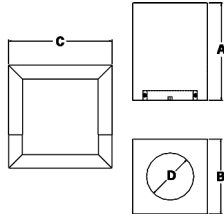
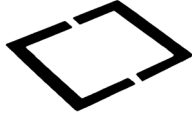

Part No.	A	B	C	D
4DRSB	14"	11 ³ / ₈ "	15 ³ / ₈ "	6 ³ / ₄ "
5DRSB	14"	11 ³ / ₈ "	15 ³ / ₈ "	8 ¹ / ₈ "

Storm Collar



Used with a flashing and mastic to seal to vent pipe, the storm collar provides extra weather protection.

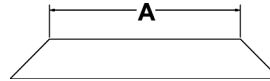

Part No.	A
4DSC	6 ⁵ / ₈ "
5DSC	8"

Flashings

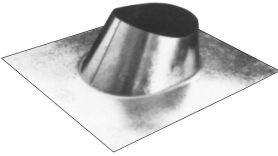

Standard Flashing

Fits flat to 5/12 pitch roofs. Double-seamed construction for protection from leakage.

Part No.	A	B	C
4DF	18 ³ / ₄ "	16"	4"
5DF	20"	17 ³ / ₄ "	4"

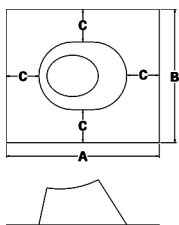

Flashing - Steep Pitch

Fits 6/12 to 12/12 pitch roofs. Double-seamed construction for protection from leakage.

Part No.	A	B	C
4DF12	22 ¹ / ₂ "	17"	4"
5DF12	21 ³ / ₄ "	21 ³ / ₄ "	4"

Includes adapters for 4" x 4", 4" x 3", and 3" x 3" systems.

Attic Insulation Shield



Use on single-story or on top story of multi-story building. Use to keep insulation from making direct contact with vent pipe.

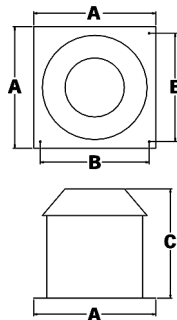

Part No.	A	B	C
4DAIS12	14"	12 ¹ / ₄ "	12"
5DAIS12	14"	12 ¹ / ₄ "	12"
4DAIS36	14"	12 ¹ / ₄ "	36"
5DAIS36	14"	12 ¹ / ₄ "	36"

Collinear Connectors



Collinear Appliance Adapter

Use at appliance for connecting from Co-axial start collars to a pair of Collinear tubes passing through existing chimneys.

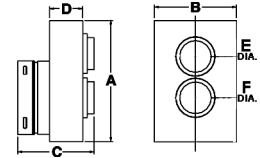

Part No.	Size	A	B	C	D	DIA. E	DIA. F
4DCAB33	4" x 6 ⁵ / ₈ "	11"	7 ¹ / ₂ "	7 ¹ / ₂ "	3"	3"	3"
4DCAB43	4" x 6 ⁵ / ₈ "	11"	7 ¹ / ₂ "	7 ¹ / ₂ "	3"	3"	4"



Collinear Top Kit

Use at top of existing chimney to convert Collinear tubes to Co-axial AmeriVent Direct Vent. Flashing is included.

Part No.	Size	A	B	C	DIA. D	DIA. E
4DCAT33	4" x 6 ⁵ / ₈ "	11"	9"	4"	3"	3"
4DCAT43	4" x 6 ⁵ / ₈ "	11"	9"	4"	3"	4"

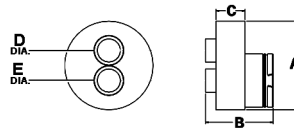

Homestyle™ Collection Collinear Direct Vent Caps

These stylish direct vent caps terminate a collinear direct vent system, while enhancing the look of any home. They are available in aluminum, black powder-coated, and solid copper with universal and fitted bottoms. Sizes include 9" x 9", 9" x 13", 13" x 13", 13" x 18", and 18" x 18". Stainless steel clamps are included to attach to flexible vent.

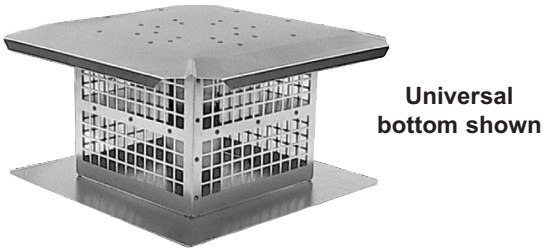

Universal bottom shown

Collinear Caps, 9" x 9"

Part No.	Finish	Size	Body Style	Vent Style
HCL-99U-33	Aluminum	9" x 9" Body	Universal Bottom	3" Vent & 3" Intake
HCL-99F-33	Aluminum	9" x 9" Body	Fitted Bottom	3" Vent & 3" Intake
HCL-99U-33B	Black Powder-Coated	9" x 9" Body	Universal Bottom	3" Vent & 3" Intake
HCL-99F-33B	Black Powder-Coated	9" x 9" Body	Fitted Bottom	3" Vent & 3" Intake
HCL-99U-33C	Solid Copper	9" x 9" Body	Universal Bottom	3" Vent & 3" Intake



Fitted bottom shown

Collinear Caps, 9" x 13"

Part No.	Finish	Size	Body Style	Vent Style
HCL-913U-33	Aluminum	9" x 13" Body	Universal Bottom	3" Vent & 3" Intake
HCL-913U-43	Aluminum	9" x 13" Body	Universal Bottom	4" Vent & 3" Intake
HCL-913U-44	Aluminum	9" x 13" Body	Universal Bottom	4" Vent & 4" Intake
HCL-913F-33	Aluminum	9" x 13" Body	Fitted Bottom	3" Vent & 3" Intake
HCL-913F-43	Aluminum	9" x 13" Body	Fitted Bottom	4" Vent & 3" Intake
HCL-913F-44	Aluminum	9" x 13" Body	Fitted Bottom	4" Vent & 4" Intake
HCL-913U-33B	Black Powder-Coated	9" x 13" Body	Universal Bottom	3" Vent & 3" Intake
HCL-913U-43B	Black Powder-Coated	9" x 13" Body	Universal Bottom	4" Vent & 3" Intake
HCL-913U-44B	Black Powder-Coated	9" x 13" Body	Universal Bottom	4" Vent & 4" Intake
HCL-913F-33B	Black Powder-Coated	9" x 13" Body	Fitted Bottom	3" Vent & 3" Intake
HCL-913F-43B	Black Powder-Coated	9" x 13" Body	Fitted Bottom	4" Vent & 3" Intake
HCL-913F-44B	Black Powder-Coated	9" x 13" Body	Fitted Bottom	4" Vent & 4" Intake
HCL-913F-33C	Solid Copper	9" x 13" Body	Fitted Bottom	3" Vent & 3" Intake
HCL-913F-43C	Solid Copper	9" x 13" Body	Fitted Bottom	4" Vent & 3" Intake
HCL-913F-44C	Solid Copper	9" x 13" Body	Fitted Bottom	4" Vent & 4" Intake

Homestyle™ and Real Flue™ are trademarks of RLH Industries, Inc.

Homestyle™ Collection Collinear Direct Vent Caps

These stylish direct vent caps terminate a collinear direct vent system, while enhancing the look of any home. They are available in aluminum, black powder-coated, and solid copper with universal and fitted bottoms. Sizes include 9" x 9", 9" x 13", 13" x 13", 13" x 18", and 18" x 18". Stainless steel clamps are included to attach to flexible vent.

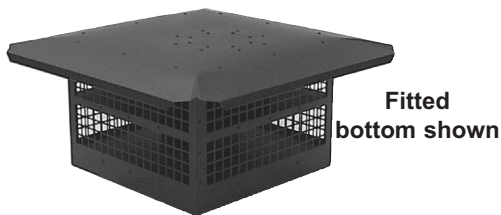

Collinear Caps, 13" x 13"

Part No.	Finish	Size	Body Style	Vent Style
HCL-1313U-33	Aluminum	13" x 13" Body	Universal Bottom	3" Vent & 3" Intake
HCL-1313U-43	Aluminum	13" x 13" Body	Universal Bottom	4" Vent & 3" Intake
HCL-1313U-44	Aluminum	13" x 13" Body	Universal Bottom	4" Vent & 4" Intake
HCL-1313F-33	Aluminum	13" x 13" Body	Fitted Bottom	3" Vent & 3" Intake
HCL-1313F-43	Aluminum	13" x 13" Body	Fitted Bottom	4" Vent & 3" Intake
HCL-1313F-44	Aluminum	13" x 13" Body	Fitted Bottom	4" Vent & 4" Intake
HCL-1313U-33B	Black Powder-Coated	13" x 13" Body	Universal Bottom	3" Vent & 3" Intake
HCL-1313U-43B	Black Powder-Coated	13" x 13" Body	Universal Bottom	4" Vent & 3" Intake
HCL-1313U-44B	Black Powder-Coated	13" x 13" Body	Universal Bottom	4" Vent & 4" Intake
HCL-1313F-33B	Black Powder-Coated	13" x 13" Body	Fitted Bottom	3" Vent & 3" Intake
HCL-1313F-43B	Black Powder-Coated	13" x 13" Body	Fitted Bottom	4" Vent & 3" Intake
HCL-1313F-44B	Black Powder-Coated	13" x 13" Body	Fitted Bottom	4" Vent & 4" Intake
HCL-1313F-33C	Solid Copper	13" x 13" Body	Fitted Bottom	3" Vent & 3" Intake
HCL-1313F-43C	Solid Copper	13" x 13" Body	Fitted Bottom	4" Vent & 3" Intake
HCL-1313F-44C	Solid Copper	13" x 13" Body	Fitted Bottom	4" Vent & 4" Intake

Homestyle™ and Real Flue™ are trademarks of RLH Industries, Inc.

Homestyle™ Collection Collinear Direct Vent Caps

These stylish direct vent caps terminate a collinear direct vent system, while enhancing the look of any home. They are available in aluminum, black powder-coated, and solid copper with universal and fitted bottoms. Sizes include 9" x 9", 9" x 13", 13" x 13", 13" x 18", and 18" x 18". Stainless steel clamps are included to attach to flexible vent.



Collinear Caps, 13" x 18"

Part No.	Finish	Size	Body Style	Vent Style
HCL-1318F-33	Aluminum	13" x 18" Body	Fitted Bottom	3" Vent & 3" Intake
HCL-1318F-43	Aluminum	13" x 18" Body	Fitted Bottom	4" Vent & 3" Intake
HCL-1318F-44	Aluminum	13" x 18" Body	Fitted Bottom	4" Vent & 4" Intake
HCL-1318F-33B	Black Powder-Coated	13" x 18" Body	Fitted Bottom	3" Vent & 3" Intake
HCL-1318F-43B	Black Powder-Coated	13" x 18" Body	Fitted Bottom	4" Vent & 3" Intake
HCL-1318F-44B	Black Powder-Coated	13" x 18" Body	Fitted Bottom	4" Vent & 4" Intake
HCL-1318F-33C	Solid Copper	13" x 18" Body	Fitted Bottom	3" Vent & 3" Intake
HCL-1318F-43C	Solid Copper	13" x 18" Body	Fitted Bottom	4" Vent & 3" Intake
HCL-1318F-44C	Solid Copper	13" x 18" Body	Fitted Bottom	4" Vent & 4" Intake



Collinear Caps, 18" x 18"

Part No.	Finish	Size	Body Style	Vent Style
HCL-1818F-33	Aluminum	18" x 18" Body	Fitted Bottom	3" Vent & 3" Intake
HCL-1818F-43	Aluminum	18" x 18" Body	Fitted Bottom	4" Vent & 3" Intake
HCL-1818F-44	Aluminum	18" x 18" Body	Fitted Bottom	4" Vent & 4" Intake
HCL-1818F-33B	Black Powder-Coated	18" x 18" Body	Fitted Bottom	3" Vent & 3" Intake
HCL-1818F-43B	Black Powder-Coated	18" x 18" Body	Fitted Bottom	4" Vent & 3" Intake
HCL-1818F-44B	Black Powder-Coated	18" x 18" Body	Fitted Bottom	4" Vent & 4" Intake
HCL-1818F-33C	Solid Copper	18" x 18" Body	Fitted Bottom	3" Vent & 3" Intake
HCL-1818F-43C	Solid Copper	18" x 18" Body	Fitted Bottom	4" Vent & 3" Intake
HCL-1818F-44C	Solid Copper	18" x 18" Body	Fitted Bottom	4" Vent & 4" Intake

Homestyle™ and Real Flue™ are trademarks of RLH Industries, Inc.

Flexible Vent Pipe

Flexible 2-ply aluminum vent used for collinear and co-axial vent systems.

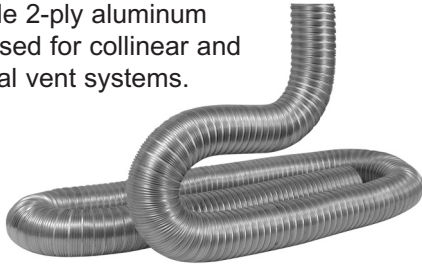

Part No.	Size	Used With
3AFL-35	3" x 35'	Collinear Vent Systems
4AFL-35	4" x 35'	Collinear and Co-Axial Vent Systems
7AFL-25K	7" x 35'	Co-Axial Vent Systems, includes pipe and fittings
7AFL-35K	7" x 35'	Co-Axial Vent Systems, includes pipe and fittings

Chimney Conversion Kits

See conversion illustrations on page 15.

Class A

8" Metal Chimney Conversion Kit

The Co-axial Chimney Kit is used when converting an existing 8" factory-built chimney to a direct vent appliance. Includes a black Conversion Adapter (4DCNA) and an unpainted large Cap Adapter (4DCAA). Uses a UL-listed 4" aluminum flex vent pipe and a 7" aluminum flex vent pipe (sold separately).

Part No.	Description
4DRCKA	8" Metal Chimney Conversion Kit

Components

4DCNA	Conversion Adapter
4DCAA	Cap Adapter - Large

Masonry Chimney Conversion Kit

The Masonry Chimney Kit is used when converting an existing masonry chimney to a direct vent appliance. Includes a black Conversion Adapter (4DCNA), an unpainted small Cap Adapter (4DCAB), a black Face Plate (4DFPB), and a square flashing. Uses a UL-listed 4" flex vent pipe and a 7" flex vent pipe (sold separately).

Part No.	Description
4DRCKM	Masonry Chimney Conversion Kit

Components

4DCNA	Conversion Adapter
4DCAB	Cap Adapter - Small
4DFPB	Face Plate
117413	Flashing 17" x 17"

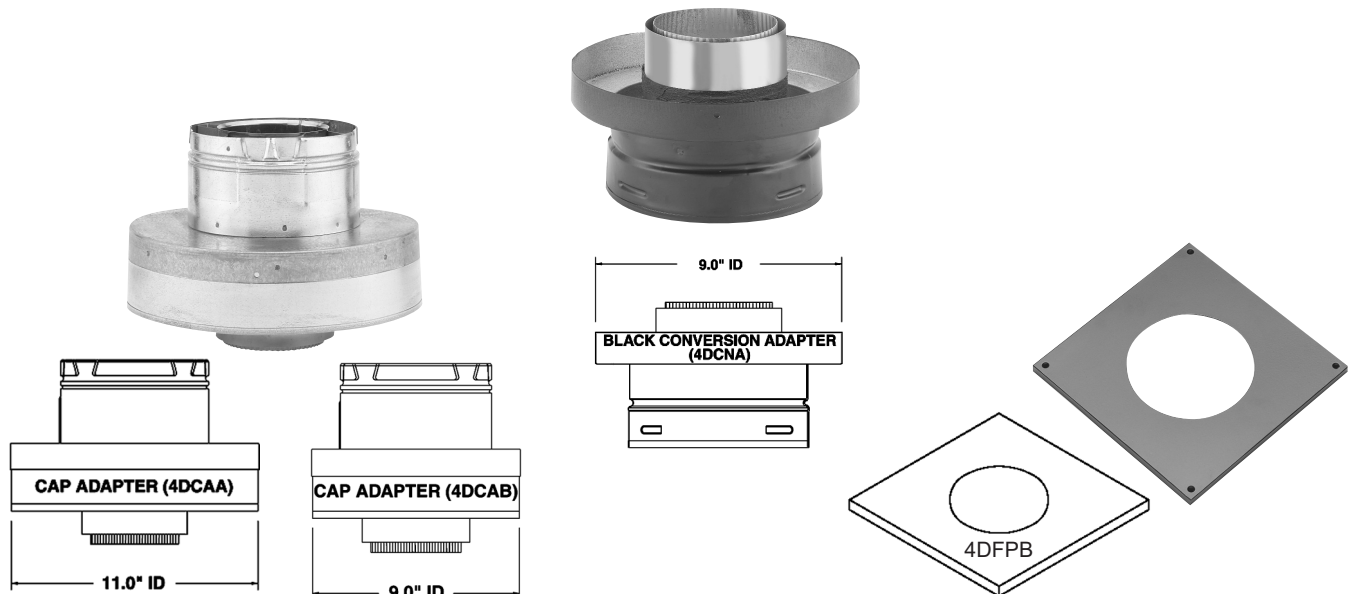

Termination Kits

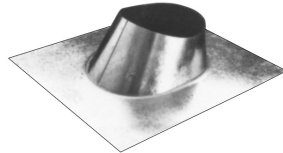

Vertical Termination Kit
Kit includes vertical cap, storm collar and standard flashing.

Part No.	Description
4DGTK	Vertical Kit

Components

4DVC	Vertical Cap
4DSC	Storm Collar
4DF	Standard Flashing

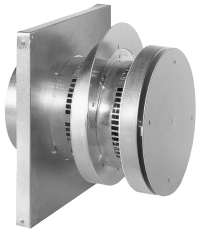
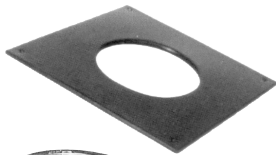

Horizontal Termination Kit #1
Kit includes black 90° elbow, black face plate, round horizontal cap, 24" black length and 12" adjustable black length.

Part No.	Description
4DHTK1	Horizontal Kit #1

Components

4D90LB	90° Elbow - Black
4DFPB	Face Plate
4DHC	Round Horizontal Cap
4D2B	24" Length - Black
4D12AB	12" Adjustable Length - Black

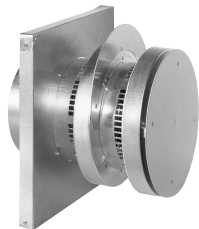
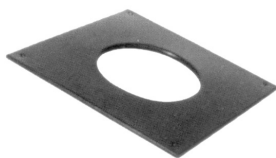

Horizontal Termination Kit #2
Kit includes black 90° elbow, black face plate and round horizontal cap.

Part No.	Description
4DHTK2	Horizontal Kit #2

Components

4D90LB	90° Elbow - Black
4DFPB	Face Plate
4DHC	Round Horizontal Cap

Adapters



Valor Adapter
 Engineered for Valor fireplaces, requiring 4" x 6⁵/₈" direct vent venting.

<u>Part No.</u>	<u>Description</u>
4DSC-V	Valor Adapter



Kingsman Adapter
 For use specifically with 4" x 7" Kingsman appliances.

<u>Part No.</u>	<u>Description</u>
4DSC-K	Kingsman Adapter



4DSC-N2

Napoleon Adapters
 For use specifically with Napoleon and Continental fireplaces and stoves.

<u>Part No.</u>	<u>Description</u>
4DSC-N2	Napoleon Adapter - Mill
4DSCB-N1	Napoleon Adapter - Black
5DSC-N	Napoleon Adapter



4DSCB-N1



4DSC-N

Typical AmeriVent Direct Vent Installations

Vertical Installation

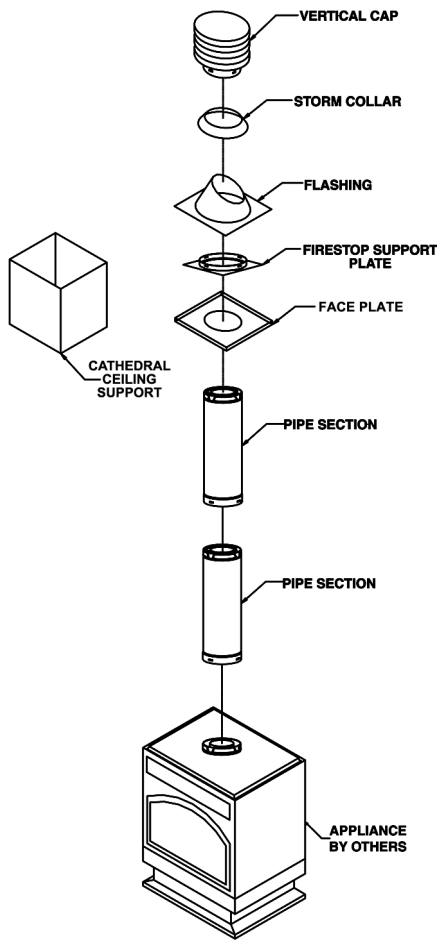

Vertical to Horizontal Installation

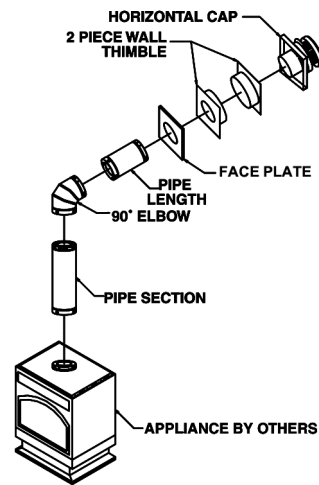

Rear Exit Horizontal Installation

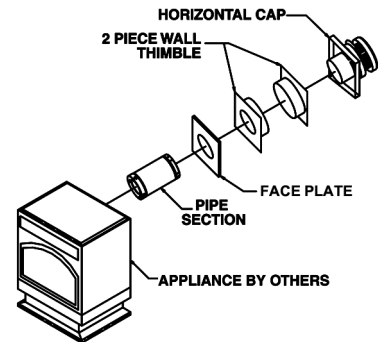

Class A Conversion Installation

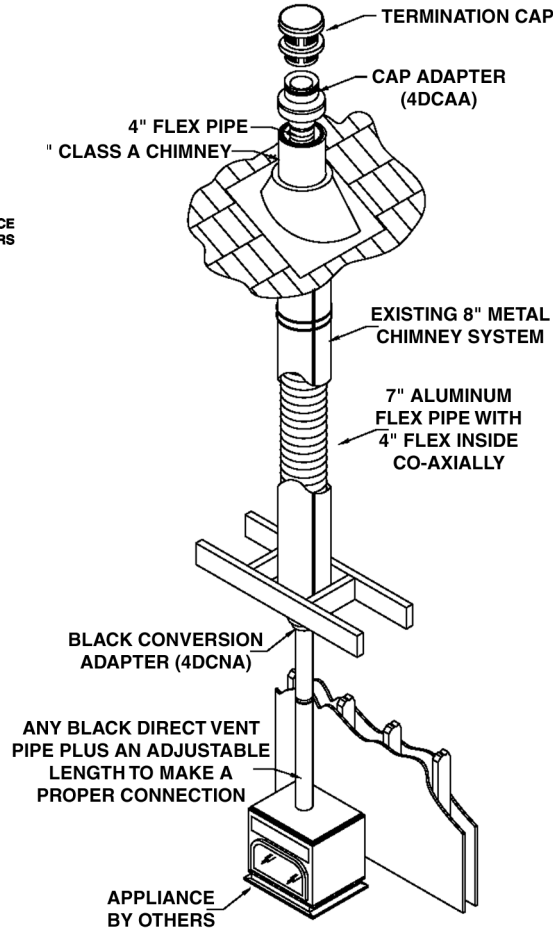

Masonry Conversion Installation

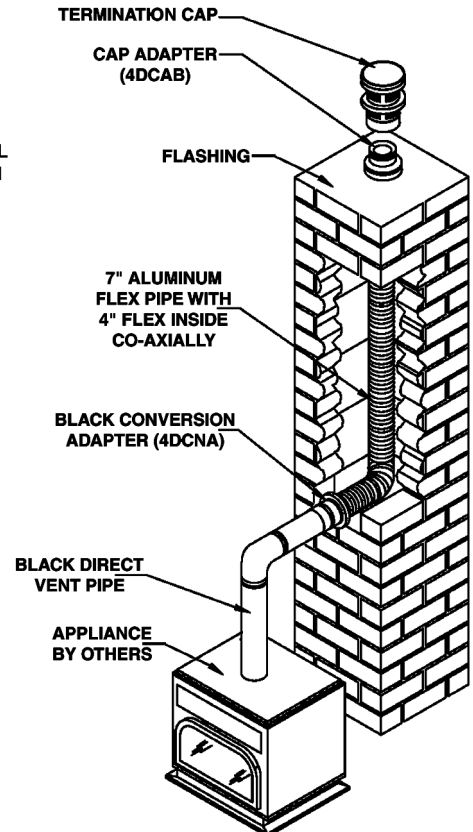

45° Elbow Pipe Offsets

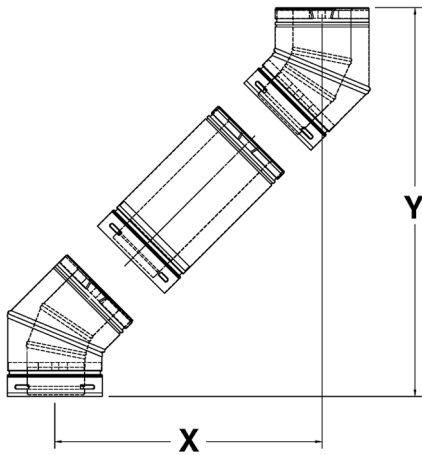

4" x 6 ⁵ / ₈ " 45° Elbow			5" x 8" 45° Elbow		
Pipe Length	X - Run	Y - Rise	Pipe Length	X - Run	Y - Rise
two 45's only	6"	14 ¹ / ₈ "	two 45's only	5 ³ / ₄ "	15 ³ / ₁₆ "
7"	9 ³ / ₁₆ "	18 ³ / ₁₆ "	7"	9 ¹ / ₂ "	19"
12"	12 ³ / ₄ "	21 ³ / ₄ "	12"	13"	22 ¹ / ₂ "
24"	21 ¹ / ₄ "	30 ¹ / ₄ "	24"	21 ¹ / ₂ "	31"
36"	29 ¹¹ / ₁₆ "	38 ¹¹ / ₁₆ "	36"	30"	39 ¹ / ₂ "
48"	38 ³ / ₁₆ "	47 ³ / ₁₆ "	48"	38 ¹ / ₂ "	48"

NOTES

NOTES

NOTES



AMERICAN METAL[®] PRODUCTS GROUP

American Metal Products Group
5030 Corporate Exchange Blvd. SE
Grand Rapids, MI 49512
www.americanmetalproducts.com

800-423-4270 toll-free
616-656-8400 phone
800-626-3825 toll-free fax
616-656-6388 fax



**ALL-FUEL CHIMNEY
MODEL HS/HSS**



**ALL-FUEL CHIMNEY
MODEL TLC**

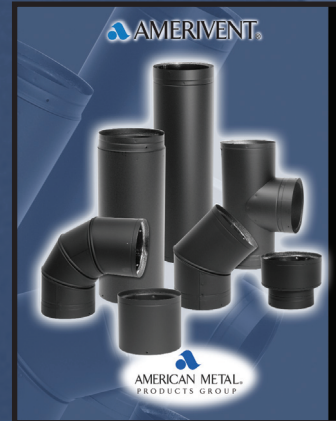

BLACK STOVEPIPE



DIRECT VENT



**MODEL CV
SPECIAL GAS VENT**

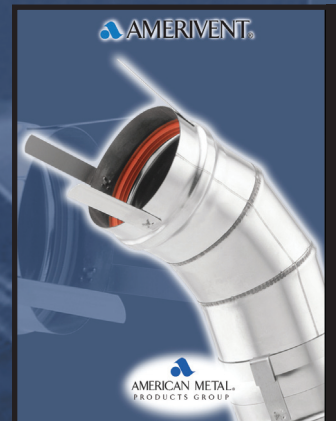

**MODEL SW
SPECIAL GAS VENT**



**PELLET PIPE PLUS
MODEL PVP**



PELLET VENT



TYPE B GAS VENT