

SKYTECH

CONTROL SYSTEMS

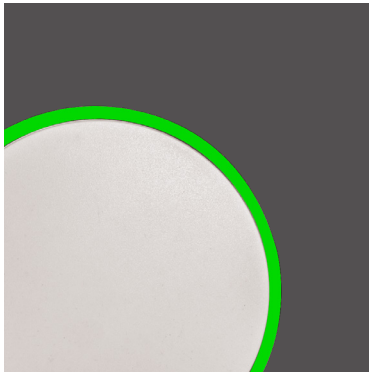

REMOTE SYSTEMS
VALVE SYSTEMS
& ACCESSORIES

FOR THE HEARTH INDUSTRY

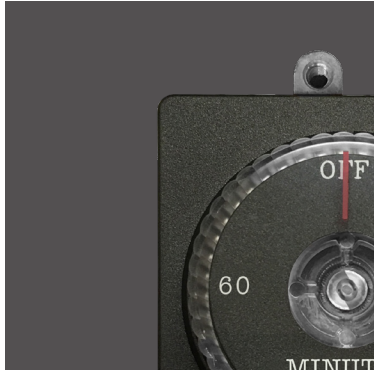
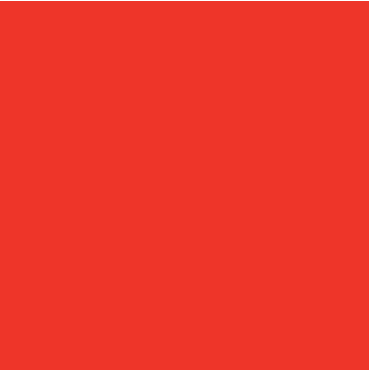

PRODUCT CATALOG

Index

REMOTE SYSTEMS

SMART DEVICE	8
ON / OFF	10
THERMOSTAT	12
PROGRAMMABLE	14
SOLENOID & DC MOTOR	15
WIRELESS WALL MOUNT	16
WIRED WALL MOUNT	17
ACCESSORIES	18
PRIVATE LABELING	19
POINT OF PURCHASE	20

VALVE SYSTEMS

AF-LMF SERIES	26
AFVK-SP SERIES	30
E-STOP GAS TIMER	32

FAN SYSTEMS

F-180	36
F-165	37
FSCRF SERIES	38
ACCESSORIES	39

ACCESSORIES

FLEX LINES	40
FITTINGS	41
GEMSTONES	42
MAP POLICY & WARRANTY	43
ONLINE RESOURCES	43

We have it all

Skytech has been a recognized leader in fireplace remote systems for more than 20 years and is synonymous with bold innovations, rock solid reliability and unrivaled customer support. That's why, when the hearth industry needs something done right the first time, they look no further than the experts at Skytech.

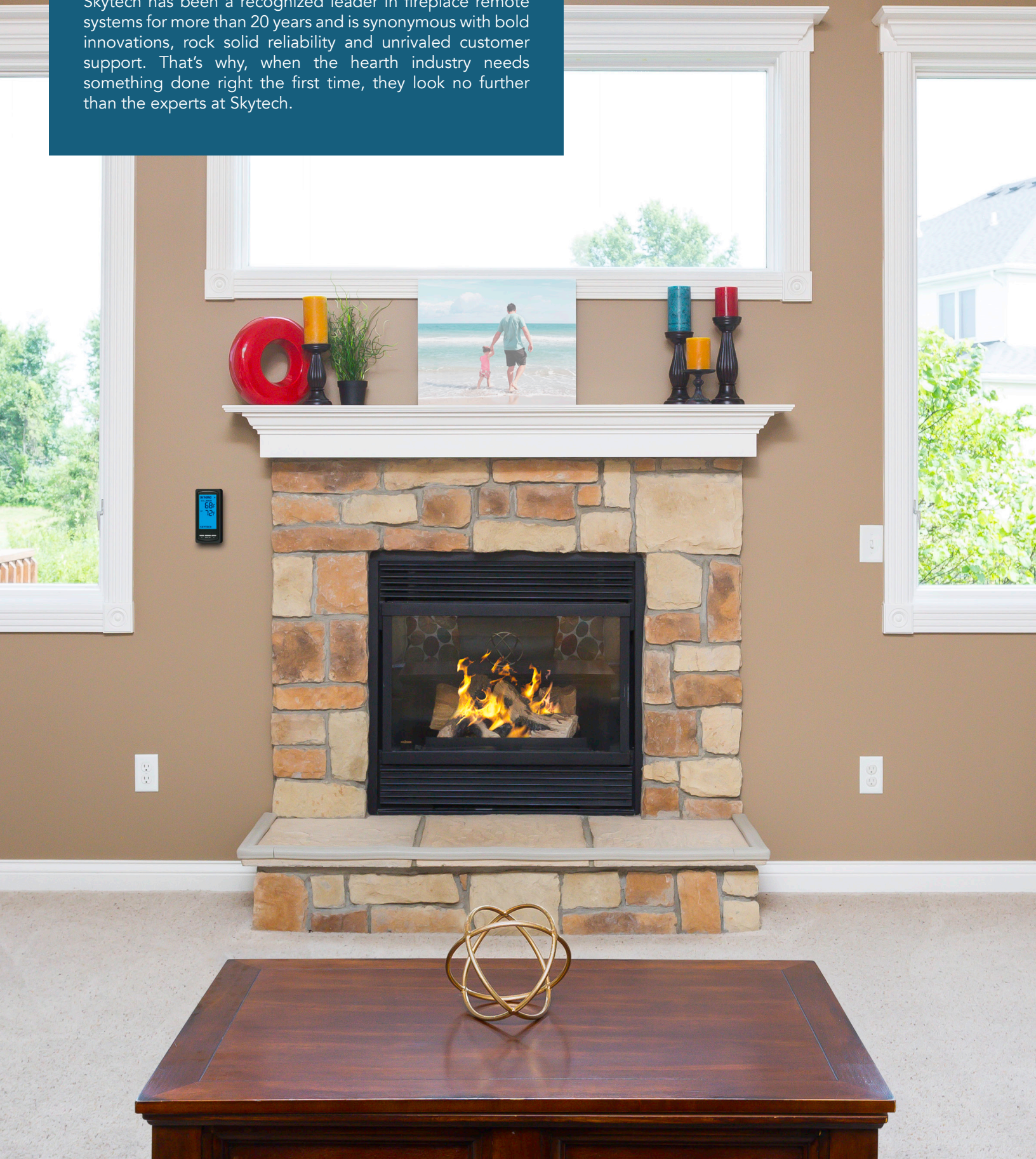

REMOTE SYSTEMS

SMART DEVICE | ON / OFF | THERMOSTAT | PROGRAMMABLE

WIRELESS WALL MOUNT | WIRED WALL MOUNT | SOLENOID & DC MOTOR

ACCESSORIES | PRIVATE LABELING | POINT OF PURCHASE





REMOTE SYSTEMS

HOW THEY WORK

If you replace your existing fireplace wall switch with our receiver combined with our uniquely designed wall plate, you will connect your existing low voltage wires to the receiver.



If you ever need any help or have any questions, we are available by phone Monday through Friday. Call 855.498.8324.



In most fireplaces, the components that you need to connect to are in a space located underneath the firebox and behind the louver. You can either place the receiver underneath the firebox or at your existing wall switch location.



HOW IT COMMUNICATES

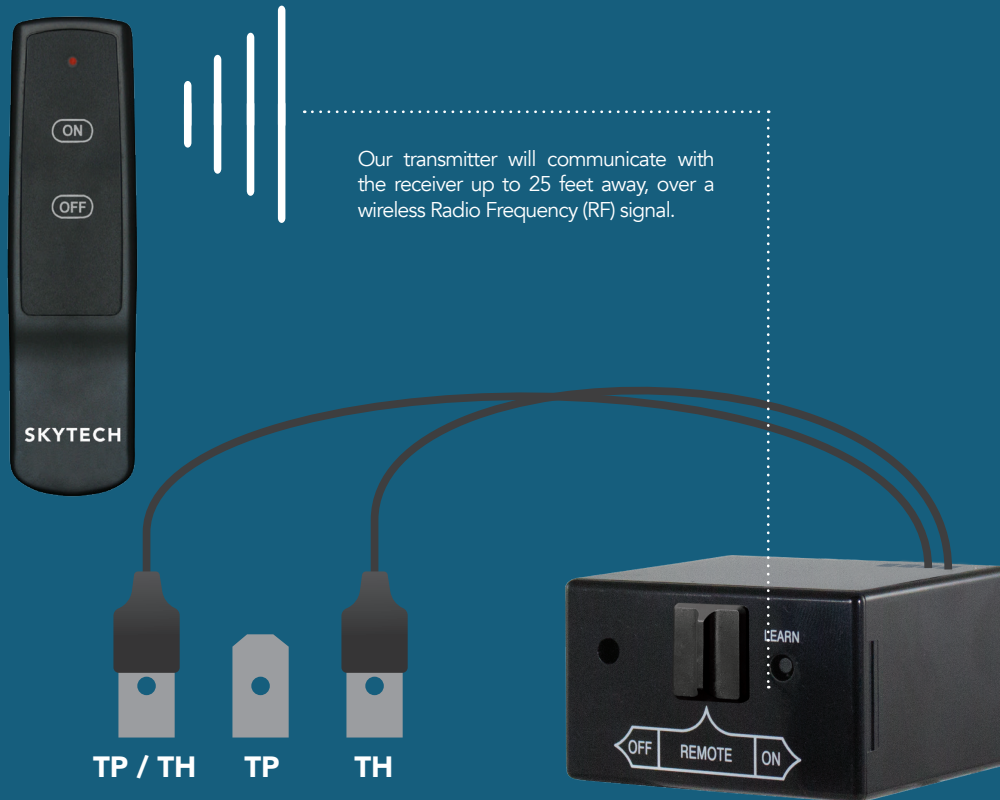

Underneath the fireplace, you will find a valve that will have these three terminals on it: TP/TH, TP, and TH. The receiver wires will connect to the TP/TH and the TH terminals.

For IPI Systems, connect the receiver wires to the on/off switch wires.

BATTERY / 110 VOLT RECEIVER



BATTERY RECEIVER

Operates on 4-AA batteries. Able to place your receiver in any location away from an outlet.



110VAC RECEIVER

All the same functionality as the battery powered receiver. No need to replace batteries.

SMART DEVICE REMOTE SYSTEMS

WARRANTY

5 Year limited warranty on all remote systems



7060 SkyBridge



Capable of connecting the included receiver with your phone to control your fireplace (No WiFi connectivity)

Easy set up and in-app tutorials

Button On/Off remote with simple push-button operation

All battery operated transmitter & plug-in receiver - RF

10,000,000 security codes

Programmable On/Off operation

Receiver will learn up to two additional Skytech transmitters

BOX INCLUDES: Transmitter, Receiver, Bridge, Batteries, Hardware Bag, Instructions

SkyBridge COMPATIBLE ACCESSORIES



7001 SkyBridge Compatible



Simple push-button On / Off operation

Single click for ON, double click for OFF

All battery operated transmitter & receiver - RF

10,000,000 security codes

Optional mounting hardware included

Receiver will learn up to two additional Skytech Transmitters

BOX INCLUDES: Transmitter, Receiver, Batteries, Hardware Bag, Instructions



7015 SkyBridge Compatible



1800 watt capacity

Simple push-button On / Off operation

Single click for ON, double click for OFF

All battery operated transmitter & plug-in receiver - RF

10,000,000 security codes

Receiver will learn up to two additional Skytech transmitters

BOX INCLUDES: Transmitter, Receiver, Batteries, Hardware Bag, Instructions

HOW THE 7060 SkyBridge COMMUNICATES

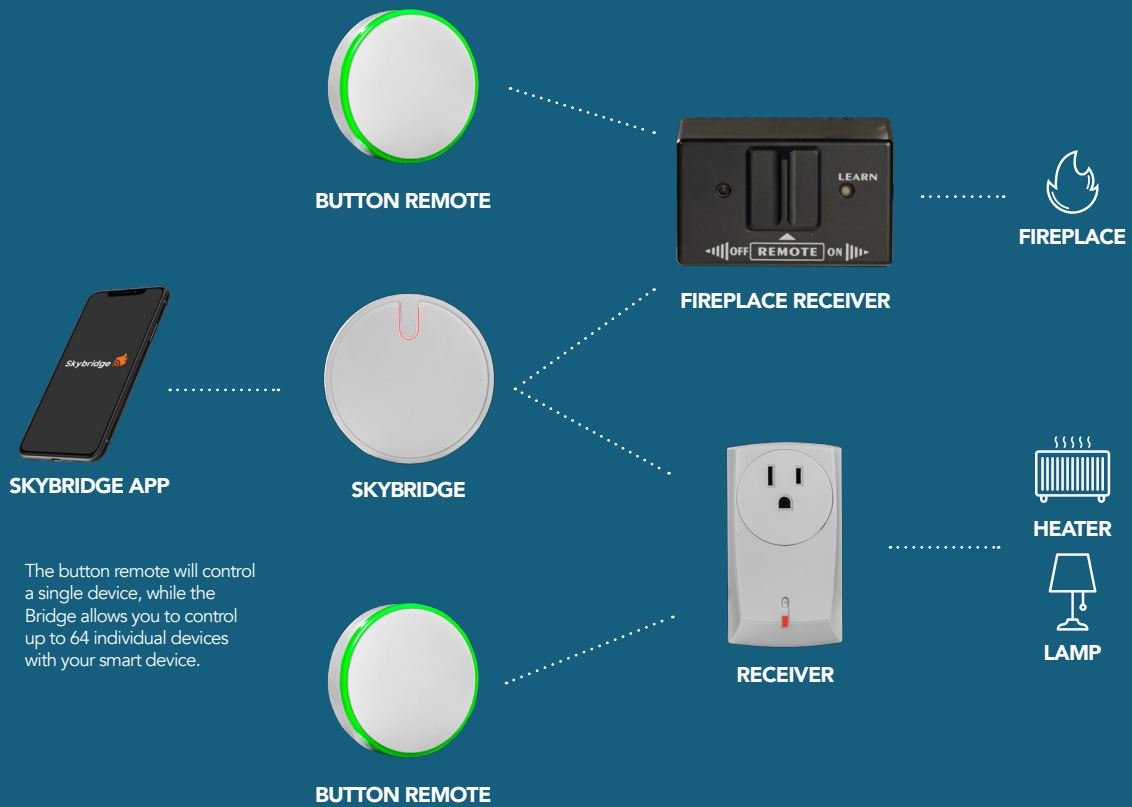

HOW THE 7001 COMMUNICATES



HOW THE 7015 COMMUNICATES



ON/OFF

REMOTE SYSTEMS

WARRANTY

5 Year limited warranty on all remote systems



7060 SkyBridge

Capable of connecting the included receiver with your phone to control your fireplace (No WiFi connectivity)

Easy set up and in-app tutorials

Button On/Off remote with simple push-button operation

10,000,000 security codes

Programmable On/Off operation

All battery operated transmitter & plug-in receiver - RF

Receiver will learn up to two additional Skytech transmitters

BOX INCLUDES: Transmitter, Receiver, Bridge, Batteries, Hardware Bag, Instructions



7001 SkyBridge Compatible

Simple push-button On / Off operation

Single click for ON, double click for OFF

All battery operated transmitter & receiver - RF

10,000,000 security codes

Optional mounting hardware included

Receiver will learn up to two additional Skytech Transmitters

BOX INCLUDES: Transmitter, Receiver, Batteries, Hardware Bag, Instructions



7015 SkyBridge Compatible

1800 watt capacity

Simple push-button On / Off operation

Single click for ON, double click for OFF

All battery operated transmitter & plug-in receiver - RF

10,000,000 security codes

Receiver will learn up to two additional Skytech transmitters

BOX INCLUDES: Transmitter, Receiver, Batteries, Hardware Bag, Instructions



1001-A

All battery operated transmitter & receiver - RF

On/Off transmitter

65,536 security codes

All batteries and wall clip included

Receiver will learn up to two additional Skytech transmitters

BOX INCLUDES: Transmitter, Receiver, Wall Plate, Batteries, Hardware Bag, Wall Clip, Instructions



1420-A

Battery operated transmitter - RF

110VAC plug-in receiver

ON/OFF transmitter

65,536 security codes

110VAC receiver, slide switch ON/REMOTE/OFF to manually operate the appliance

Receiver will learn up to two additional Skytech transmitters

BOX INCLUDES: Transmitter, Receiver, Batteries, Hardware Bag, Wall Clip, Instructions



1001T-LCD-A

All battery operated transmitter & receiver - RF

ON/OFF transmitter

LCD display room temperature in °F or °C,

3-hour countdown timer

Flame indicator

Low battery indicator

65,536 security codes

Child safety lock out

Receiver will learn up to two additional Skytech transmitters

BOX INCLUDES: Transmitter, Receiver, Wall Plate, Batteries, Hardware Bag, Wall Clip, Instructions



1420TLCD-A

- Battery operated transmitter - RF
- 110VAC plug-in receiver
- ON/OFF transmitter
- LCD display room temperature in °F or °C, 3-hour countdown timer
- Flame indicator
- Low battery indicator
- Child safety lock out
- 65,536 security codes
- 110VAC receiver, slide switch ON/REMOTE/OFF to manually operate the appliance
- Receiver will learn up to two additional Skytech transmitters

BOX INCLUDES: Transmitter, Receiver, Batteries, Hardware Bag, Wall Clip, Instructions



1001-A-FSCRF

Automatically turns the fireplace fan on in 7 minutes from when the fireplace is turned on and turns the fan off in 12 minutes after the fireplace is turned off.

Battery operated easy-to-use on/off transmitter

110VAC plug-in receiver (no need to change receiver batteries)

"Set it and forget it" adjustable fan speed control receiver remembers your desired fan speed.

Four (4) fan speed settings and an Off setting.

65,536 security codes

Compatible with Millivolt and most Electronic Ignition controls.

BOX INCLUDES: Transmitter, Speed Control Receiver, Hardware Bag, Instructions



1001D-A

- All battery operated transmitter & receiver - RF
- Wireless wall switch, surface mount
- 65,536 security codes
- Receiver will learn up to two additional Skytech transmitters

BOX INCLUDES: Transmitter, Receiver, Wall Plate, Batteries, Hardware Bag, Instructions

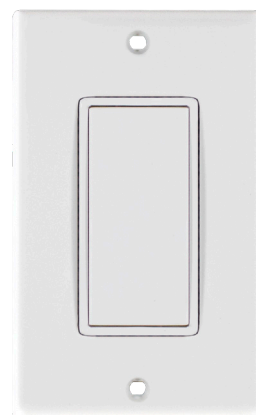

WS

Wired wall switch

Decorative rocker-style wall switch and cover plate

UL listed switch

20 feet of 18-2 low-voltage wire included

BOX INCLUDES: Switch, Wall Plate, 20' wire, Hardware Bag, Instructions

THERMOSTAT

REMOTE SYSTEMS

WARRANTY

5 Year limited warranty on all remote systems



5301

All battery operated transmitter & receiver - RF
1,048,576 security codes
Touchscreen transmitter
Backlit LCD screen
Thermostatic control
Flame indicator
Low battery indicator
9-hour countdown timer
Child safety lock out
Wall mount docking station
BOX INCLUDES: Transmitter, Receiver, Wall Plate, Batteries, Hardware Bag, Wall Mount, Instructions



5320

Battery operated transmitter - RF
110VAC plug-in receiver
1,048,576 security codes
Touchscreen transmitter
Backlit LCD screen
Thermostatic control
Flame indicator
Low battery indicator
9-hour countdown timer
Child safety lock out
Wall mount docking station
BOX INCLUDES: Transmitter, Receiver, Wall Mount, Batteries, Hardware Bag, Instructions



SMART-BATT



On / Off / Thermostat remote
All battery operated
Backlit LCD
All batteries included
9-Hour countdown timer
1,048,576 security codes
Child safety lockout
Auto safety shutdown (9 hours)
Low battery indicator
Wall mount bracket included
Limited lifetime 5 year warranty

BOX INCLUDES: Transmitter, Receiver, Hardware Bag, Wall Clip, Instructions



SMART-STAT



On / Off / Thermostat remote
110 volt receiver
Backlit LCD
All batteries included
9-Hour countdown timer
1,048,576 security codes
Child safety lockout
Auto safety shutdown (9 hours)
Low battery indicator
Wall mount bracket included
Limited lifetime 5 year warranty

BOX INCLUDES: Transmitter, Receiver, Batteries, Hardware Bag, Wall Clip, Instructions



3301

All Battery operated transmitter & receiver - RF
1,048,576 security codes
LCD displays both room and thermostat set temperature in °F or °C
Thermostatic control
9-hour countdown timer and 24-hour clock
Flame indicator
Low battery indicator
Child safety lock out
Swing temperature (adjustable 1 - 3 degrees)

BOX INCLUDES: Transmitter, Receiver, Wall Mount, Wall Plate, Batteries, Hardware Bag, Instructions



1420TH-A

Battery operated transmitter - RF
 110VAC plug-in receiver
 ON/OFF transmitter
 LCD display room and thermostat temperature in °F or °C
 Flame indicator
 Low battery indicator
 65,536 security codes
 Child safety lock out
 110VAC receiver, slide switch ON/REMOTE/OFF to manually operate the appliance
 Receiver will learn up to two additional Skytech transmitters
BOX INCLUDES: Transmitter, Receiver, Hardware Bag, Wall Clip, Instructions



1001TH-A

All battery operated transmitter & receiver - RF
 4-button ON/OFF/MODE/SET transmitter
 LCD display room and thermostat temperature in °F or °C
 Flame indicator
 Low battery indicator
 65,536 security codes
 Receiver will learn up to two additional Skytech transmitters
BOX INCLUDES: Transmitter, Receiver, Wall Plate, Batteries, Hardware Bag, Wall Clip, Instructions



3301-A-FSCR

Automatically turns the fireplace fan on in 7 minutes from when the fireplace is turned on and turns the fan off in 12 minutes after the fireplace is turned off.
 "Set it and forget it" adjustable fan speed control receiver remembers your desired fan speed.
 Four (4) fan speed settings and an Off setting.
 Compatible with Millivolt or Electronic Ignition controls
 Battery operated transmitter
 1,048,576 security codes
 Thermostatic control
 Countdown timer
 Adjustable swing temperature
 110VAC plug-in receiver (no need to change receiver batteries)
 Compatible with Millivolt and most Electronic Ignition controls
BOX INCLUDES: Transmitter, Speed Control Receiver, Wall Mount, Batteries, Hardware Bag, Instructions



3002

All battery operated transmitter & receiver - RF
 1,048,576 security codes
 LCD displays both room and set temperature in °F or °C
 Thermostatic control
 9-hour countdown timer
 24-hour clock
 Flame indicator
 Low battery indicator
 Child safety lock out
 Swing temperature (adjustable 1 - 3 degrees)
BOX INCLUDES: Transmitter, Receiver, Wall Plate, Batteries, Hardware Bag, Instructions



TS-R-2A

All Battery operated transmitter & receiver - RF
 Wireless thermostat or manual ON/SET/OFF operation
 Large LCD screen displays room and set temperature in °F or °C
 1,048,576 security codes
 Flame indicator
BOX INCLUDES: Transmitter, Receiver, Wall Plate, Batteries, Hardware Bag, Instructions



TS-3

Wired thermostat or manual ON/SET/OFF operation surface mount
 Large LCD screen to display room and set temperature in °F or °C
 1,048,576 security codes
 Flame indicator
BOX INCLUDES: Transmitter, Batteries, Hardware Bag, Instructions

PROGRAMMABLE REMOTE SYSTEMS



5301P

All battery operated transmitter & receiver - RF
 1,048,576 security codes
 Touchscreen transmitter
 Backlit LCD screen
 Child safety lock out

Thermostatic control
 Flame indicator
 Low battery indicator
 Programmable (Weekday/Weekend) (5/2)
 Wall mount docking station

BOX INCLUDES: Transmitter, Receiver, Wall Plate, Batteries, Hardware Bag, Wall Mount, Instructions



5320P

Battery operated transmitter - RF
 110VAC plug-in receiver
 1,048,576 security codes
 Touchscreen transmitter
 Backlit LCD screen
 Child safety lock out

Thermostatic control
 Flame indicator
 Low battery indicator
 Programmable (Weekday/Weekend) (5/2)
 Wall mount docking station

BOX INCLUDES: Transmitter, Receiver, Wall Mount, Batteries, Hardware Bag, Instructions

WARRANTY
 5 Year limited warranty on all remote systems



3301P2

All battery operated transmitter & receiver - RF
 1,048,576 security codes
 Backlit LCD screen
 Thermostatic control
 Flame indicator
 Low battery indicator
 Child safety lock out
 Programmable (Weekday/Weekend) (5/2)
 Swing temperature (adjustable 1 - 3 degrees)

BOX INCLUDES: Transmitter, Receiver, Wall Mount, Wall Plate, Batteries, Hardware Bag, Instructions



3003P

All battery operated transmitter & receiver - RF
 1,048,576 security codes
 LCD displays both room and set temperature in °F or °C
 Thermostatic control
 9-hour countdown timer
 24-hour clock

Flame indicator
 Low battery indicator
 Child safety lock out
 Swing temperature (adjustable 1 - 3 degrees)
 Programmable thermostat setting, 7 days / 4 periods within one day

BOX INCLUDES: Transmitter, Receiver, Wall Plate, Batteries, Hardware Bag, Instructions

SOLENOID & DC MOTOR CONTROL

REMOTE SYSTEMS



MRCK

All battery operated transmitter & receiver - RF
Infinite flame adjustment from remote control
65,536 security codes

Single function control for operating the servo motor valve system

BOX INCLUDES: Transmitter, Receiver, Receiver Shield, Batteries, Hardware Bag, Wall Clip, Instructions



MRCK-TH

All battery operated transmitter & receiver - RF
65,536 security codes
LCD display for room and set temperature in °F or °C
Flame indicator

Low battery indicator
Child safety lock out

Thermostat control for operating the servo motor valve system

BOX INCLUDES: Transmitter, Receiver, Receiver Shield, Batteries, Hardware Bag, Wall Clip, Instructions



CON

All Battery operated transmitter & receiver - RF
ON/OFF transmitter

Single function control for operating latching solenoid gas valve systems

65,536 security codes

BOX INCLUDES: Transmitter, Receiver, Receiver Shield, Batteries, Hardware Bag, Wall Clip, Instructions

WARRANTY

5 Year limited warranty on all remote systems



CON-TH

All battery operated transmitter & receiver - RF
255 security codes

LCD display for room and set temperature in °F or °C

ON/OFF control

Flame indicator

Low battery indicator

Child safety lock out

Thermostat control for operating latching solenoid gas valve systems

BOX INCLUDES: Transmitter, Receiver, Receiver Shield, Batteries, Hardware Bag, Wall Clip, Instructions



RCT-MLT

On / Off / Thermostat multi-function remote control

1,048,576 security codes

Flame modulation (high / medium / low)

Fan speed control (high / medium / low & off)

Includes solenoid for flame modulation

9-Hour countdown timer

Child safety lockout

Auto safety shutdown (9 hours)

All batteries included

Low battery indicator

Wall mount bracket included

Limited lifetime 5 year warranty

For use with Dexen millivolt gas valves

BOX INCLUDES: Transmitter, Receiver, Solenoid, Batteries, Hardware Bag, Wall Clip, Instructions

WIRELESS WALL MOUNT

REMOTE SYSTEMS

WARRANTY

5 Year limited warranty on all remote systems



TS-R-2A

Wireless thermostat or manual ON/SET/OFF operation
All Battery operated transmitter & receiver - RF
Large LCD screen displays room and set temperature in °F or °C
1,048,576 security codes
Flame indicator
BOX INCLUDES: Transmitter, Receiver, Wall Plate, Batteries, Hardware Bag, Instructions



1001D-A

All battery operated transmitter & receiver - RF
Wireless wall switch, surface mount
65,536 security codes
Receiver will learn up to two additional Skytech transmitters
BOX INCLUDES: Transmitter, Receiver, Wall Plate, Batteries, Hardware Bag, Instructions



TM-R-2A

30 / 60 / 120 minute timer
All battery operated transmitter & receiver - RF
65,536 security codes
Receiver will learn up to two additional Skytech ON/OFF transmitters
BOX INCLUDES: Transmitter, Receiver, Wall Plate, Batteries, Hardware Bag, Instructions

WIRED WALL MOUNT

REMOTE SYSTEMS

WARRANTY

5 Year limited warranty on all remote systems



WS

Wired wall switch
Decorative rocker-style wall switch and cover plate
UL listed switch
20 feet of 18-2 low-voltage wire included
BOX INCLUDES: Transmitter, Hardware Bag, Wire, Instructions



TS-3

Wired thermostat or manual ON/SET/OFF operation surface mount
Large LCD screen to display room and set temperature in °F or °C
Flame indicator
BOX INCLUDES: Transmitter, Batteries, Hardware Bag, Instructions



TM-3

Wired 30 / 60 / 120 minute timer
Battery operated wired transmitter
BOX INCLUDES: Transmitter, Batteries, Hardware Bag, Instructions

ACCESSORIES

FOR REMOTE SYSTEMS



RS-1

Metal receiver shield
Insulated to protect from heat



RS-1A

Copolymer Tepcon material receiver cover
High temperature material
Improves RF communication



RS-2

Log-style receiver cover
Solid refractory construction

⚠ WARNING! | CALIFORNIA PROPOSITION 65
This product can expose you to Titanium Dioxide and Lithium Carbonate, which is known to the state of California to cause cancer and birth defects or other reproductive harm. (For more information, go to www.p65warnings.ca.gov)

PRIVATE LABELING

FOR REMOTE SYSTEMS



CUSTOM BRANDING

All you need to do is provide us with your logo and we will make it fit on any remote you choose.

Logo size is limited. Larger logos may not fit on these remotes.

SEE PRICE SHEET FOR DETAILS

POINT OF PURCHASE

DISPLAYS THAT MAKE A STATEMENT AND STANDS OUT



POP-7060 SkyBridge Display

Our newest 7060 system on display

Use the included receiver to install on a nearby log set to display the capability of the 7060 system

Includes literature to explain the capabilities of the 7060 remote system as well as the SkyBridge app



FRONT



BACK



POPCOUNTER

Three of our most popular remotes in one display

Features the following remotes: 1001-A / 3301 / 5301P

In stock and available for purchase

Eye-catching, three-sided design

Great physical sales tool for any type of retail establishment

A set of 3 mantel cards are also included

VALVE SYSTEMS

AF-LMF SERIES | AFVK-SP SERIES

GAS E-STOP TIMER





VALVE SYSTEMS OPTIONS

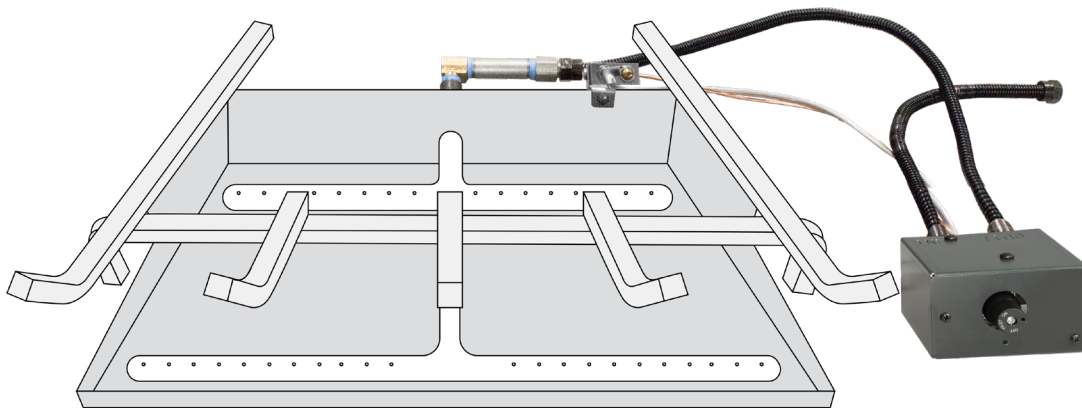

AF-LMF SERIES

PG. 26

- Standing pilot system
- Small, compact and less noticeable inside the fireplace
- Able to place a larger log set inside the fireplace because of the size
- Battery operated
- Hand-held remote control

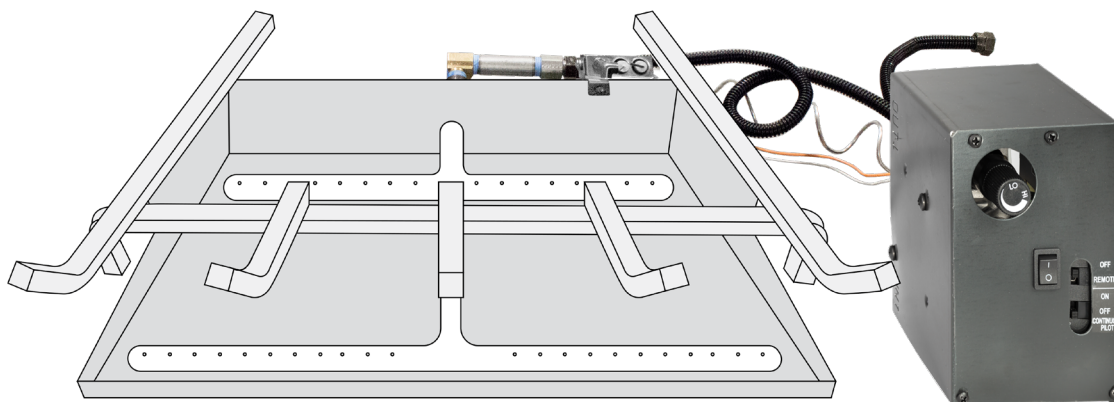

AFVK-SP SERIES

PG. 30

- Electronic spark-to-pilot ignition
- Hand-held remote control
- Battery operated

⚠ WARNING! | CALIFORNIA PROPOSITION 65
This product can expose you to Lead, which is known to the state of California to cause cancer and birth defects or other reproductive harm. (For more information, go to www.p65warnings.ca.gov)

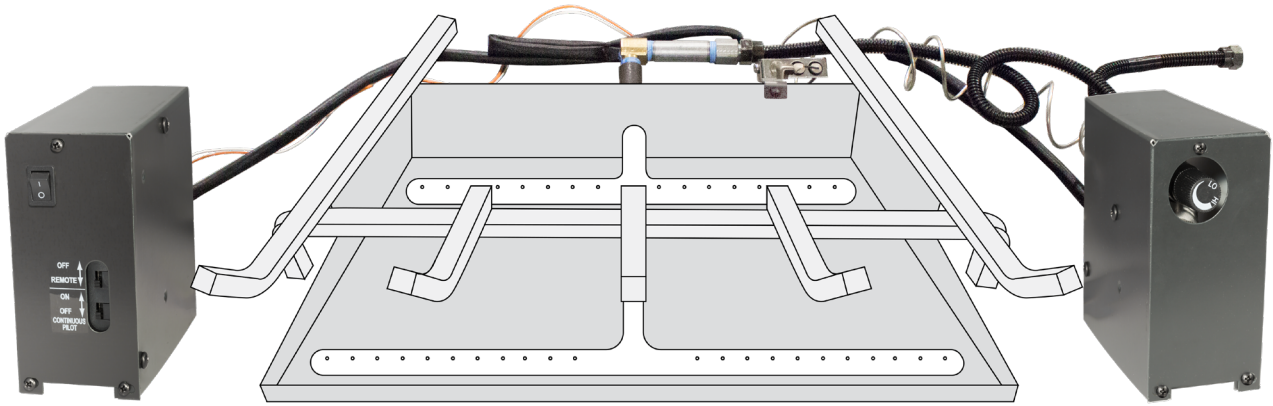

AFVK SPLIT SERIES

Electronic spark-to-pilot ignition

Able to maximize the width of your log set by keeping it centered within the fireplace

Hand-held remote control

Battery operated

If you ever need any help or have any questions, we are available by phone Monday through Friday. Call 855.498.8324.



⚠️ WARNING! | CALIFORNIA PROPOSITION 65

This product can expose you to Lead, which is known to the state of California to cause cancer and birth defects or other reproductive harm. (For more information, go to www.p65warnings.ca.gov)

AF-LMF SERIES VALVE SYSTEM

Standing pilot valve kits. To be used with indoor vented gas fireplace burners

WARRANTY

1 Year limited warranty on all valve systems. Any remote included has a 5 year limited warranty.



AF-LMF (Base Model)

30-Millivolt manual safety pilot kit measuring 3-3/4 inch W x 4 inch D x 2-3/4 inch H

225°F rated valve

Designed specifically for use with vented gas logs

Exclusive safety seal within the gas valve

Quick mount pilot assembly

Damper clamp included

Propane conversion kits available

Easy upgrade to remote operation

BOX INCLUDES: Valve Kit, Flex Line, Damper Clamp, 3/8" to 1/2" Flare Adapter, Instructions

The AF-LMF series is a standing Pilot valve kit

This AF-LMF is the base model, but you are able to upgrade the AF-LMF to suit your personal needs with our convenient **UPGRADE KITS**. You can either purchase the different packages that we offer in this catalog, or you can buy them individually. It's completely up to you how you want to customize your valve kit.

For use with indoor vented gas fireplace burners

UPGRADE KITS



RCAF-LMF

ON/OFF remote control for AF-LMF series gas valve kits

Includes solenoid, batteries, wire kit & receiver shield

255 security codes

BOX INCLUDES: Transmitter, Receiver, Wall Clip, Solenoid, Hardware bag, Batteries, Instructions



RCAF-LMF-V

Variable flame adjustment remote control for AF-LMF series gas valve kits

Includes variable flame motor drive, batteries, wire kit & receiver shield

255 security codes

BOX INCLUDES: Transmitter, Receiver, Wall Clip, Motor Drive, Extension Knob, Hardware bag, Batteries, Instructions

⚠ WARNING! | CALIFORNIA PROPOSITION 65

This product can expose you to Lead, which is known to the state of California to cause cancer and birth defects or other reproductive harm. (For more information, go to www.p65warnings.ca.gov)

AF-LMF-R



Millivolt manual safety pilot kit measuring 3-3/4 inch W x 4 inch D x 2-3/4 inch H
225°F rated valve
Designed specifically for use with vented gas logs
ON/OFF remote control included (CON)
Exclusive safety seal within the gas valve
Quick mount pilot assembly
Damper clamp included
Propane conversion kits available

The AF-LMF-R consists of the following models



AF-LMF

Base Model



RCAF-LMF

Upgrade Kit

AF-LMF-RV



Millivolt manual safety pilot kit measuring 3-3/4 inch W x 4 inch D x 2-3/4 inch H
225°F rated valve
Designed specifically for use with vented gas logs
Variable flame remote control included (RCAF-1020-1)
Exclusive safety seal within the gas valve
Quick mount pilot assembly
Damper clamp included
Propane conversion kits available

The AF-LMF-RV consists of the following models



AF-LMF

Base Model



RCAF-LMF-V

Upgrade Kit

AF-LMF SERIES CONTINUED

Standing pilot valve kits. To be used with indoor vented gas fireplace burners

WARRANTY

1 Year limited warranty on all valve systems. Any remote included has a 5 year limited warranty.

AF-LMF-RVS



Millivolt manual safety pilot kit measuring 3-3/4 inch W x 4 inch D x 2-3/4 inch H

225°F rated valve

Designed specifically for use with vented gas logs

HIGH/MED/LOW remote control included (RCAF-1035)

Exclusive safety seal within the gas valve

Quick mount pilot assembly

Damper clamp included

Propane conversion kits available

Recommended for vented gas log sets over 70,000 BTUs (See AF-LMF-RV for log sets under 70,000 BTUs)

The AF-LMF-RVS is not made up of individual parts.

BOX INCLUDES: Valve Kit, Receiver, Transmitter, Flex Line, Damper Clamp, 3/8" to 1/2" Flare Adapter, Wall Clip, Batteries, Hardware Bag, Instructions

⚠ WARNING! | CALIFORNIA PROPOSITION 65

This product can expose you to Lead, which is known to the state of California to cause cancer and birth defects or other reproductive harm. (For more information, go to www.p65warnings.ca.gov)

AF-LMF ACCESSORIES



RCAF-LMF-WWS

ON/OFF wireless wall switch for AF-LMF series gas valve kits
Included solenoid, batteries, wire kit & receiver shield
65,536 security codes

BOX INCLUDES: Transmitter, Receiver, Solenoid, Batteries, Hardware Bag, Instructions



TM-R-AF1TX

Wireless timer for use with AFVK-SP series gas valve kits
Includes 30/60/120/OFF wireless timer & batteries
65,536 security codes

BOX INCLUDES: Transmitter, Batteries, Hardware Bag, Instructions



2385-9P

Universal pilot assembly for most vented gas log sets
Mounting bracket standard
Includes 30 millivolt thermocouple
Includes aluminum pilot supply line
Optional high limit energy cutoff
Fully assembled ready to install

BOX INCLUDES: Pilot Assembly



LPK

Used to convert AF-LMF series valve kit from Natural Gas (NG) to Liquid Propane (LP).

Accommodates 18" to 24" models

BOX INCLUDES: BOX INCLUDES: Vermiculite, Elbow, Coupling, Orifices, Pilot Orifices

⚠ WARNING! | CALIFORNIA PROPOSITION 65

This product can expose you to Tetrabromobisphenol-A, which is known to the state of California to cause cancer. (For more information, go to www.p65warnings.ca.gov)

AFVK-SP SERIES VALVE SYSTEM

Electronic spark-to-pilot ignition valve kits. To be used with indoor vented gas fireplace burners

WARRANTY

1 Year limited warranty on all valve systems. Any remote included has a 5 year limited warranty.



AFVK-SP-MH-L

Spark to pilot valve kit measures 3-3/4 inch W x 5-1/2 inch D x 5-1/2 inch H

- ON/OFF/HIGH/LOW remote control included
- Infinite flame adjustment from remote control
- Continuous pilot switch on valve box and remote control
- Quick mount pilot assembly
- Damper clamp included
- Propane conversion kits are available
- All battery operated

BOX INCLUDES: Valve Kit, Transmitter (SP1001H-LTX), Flex Line, Damper Clamp, 3/8" to 1/2" Flare Adapter, Batteries, Instructions



AFVK-SP

Spark to pilot valve kit measures 3-3/4 inch W x 5-1/2 inch D x 5-1/2 inch H

- Manual flame adjustment
- ON/OFF remote control included
- Continuous pilot switch on valve box and remote control
- Quick mount pilot assembly
- Damper clamp included
- Propane conversion kits are available
- All battery operated

BOX INCLUDES: Valve Kit, Transmitter (SP1001TX), Flex Line, Damper Clamp, 3/8" to 1/2" Flare Adapter, Batteries, Instructions



AFVK-SP-MHLSPLIT

Spark to pilot valve kit measures 2-3/4 inch W x 5-3/4 inch D x 5-3/4 inch H

- High temperature cable connecting each box
- ON/OFF/HIGH/LOW remote control included
- Infinite flame adjustment from remote control
- Continuous pilot switch on valve box and remote control
- Quick mount pilot assembly
- Damper clamp included
- Propane conversion kits are available
- All battery operated

BOX INCLUDES: Valve Kit, Transmitter (SP1001H-LTX), Flex Line, Damper Clamp, 3/8" to 1/2" Flare Adapter, Batteries, Instructions

⚠ WARNING! | CALIFORNIA PROPOSITION 65

This product can expose you to Lead, which is known to the state of California to cause cancer and birth defects or other reproductive harm. (For more information, go to www.p65warnings.ca.gov)

AFVK-SP ACCESSORIES



1001D-AF1TX

Wireless wall switch transmitter for use with AFVK-SP series gas valve kits

Includes wireless ON/OFF switch & batteries

65,536 security codes

BOX INCLUDES: Transmitter, Batteries, Hardware Bag, Instructions



1322WT

Wireless Hi/Low transmitter

For use with all AFVK-SP-H-L & AFVK-SP-MH-L valve kits

Includes Hi/Low wireless transmitter & batteries

65,536 security codes

BOX INCLUDES: Transmitter, Batteries, Hardware Bag, Instructions



TM-R-AF1TX

Wireless timer for use with AFVK-SP series gas valve kits

Includes 30/60/120/OFF wireless timer & batteries

65,536 security codes

BOX INCLUDES: Transmitter, Batteries, Hardware Bag, Instructions



AF-4000ADP24-80

110VAC power source for AFVK-SP series gas valve kits

BOX INCLUDES: Power Adapter

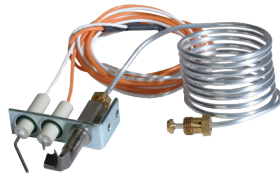

AFVK-SP-PILOT60

Natural gas pilot assembly extension

Kit provides 60 inch wire leads and pilot tubing

For use with all Skytech spark to pilot systems

BOX INCLUDES: Pilot System

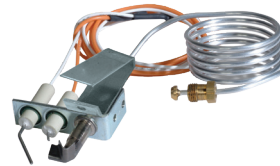

238577-13

18" pilot assembly for use on AFVK-SP series valve kits

BOX INCLUDES: Pilot System



LPK-18 / LPK-24

Used to convert AF-LMF series valve kit from Natural Gas (NG) to Liquid Propane (LP).

Accommodates 18" to 24" models

BOX INCLUDES: Vermiculite, Elbow, Coupling, Orifices, Pilot Orifices

⚠ WARNING! | CALIFORNIA PROPOSITION 65

This product can expose you to Lead, which is known to the state of California to cause cancer and birth defects or other reproductive harm. (For more information, go to www.p65warnings.ca.gov)

E-STOP GAS TIMER

MECHANICAL TIMER WITH EMERGENCY STOP

U.S. Patent No. 10,520,108

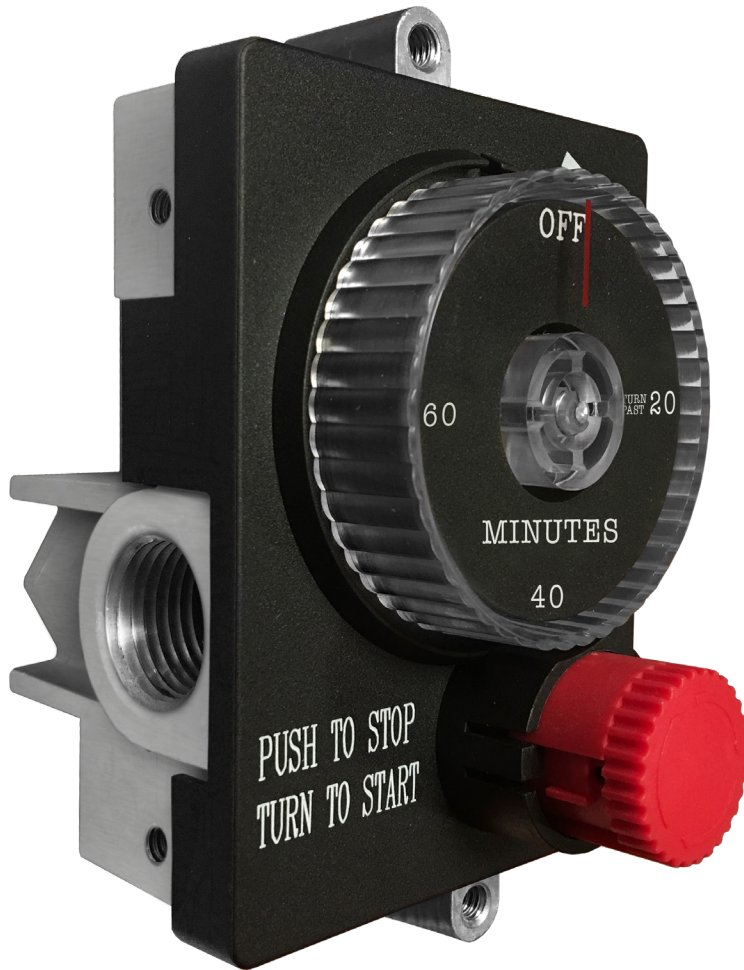

FEATURES

- Unique all mechanical gas shut-off timer with built-in emergency stop - no power required
- High BTU capacity
- Safest gas timer available in the industry
- Available in a 1 hour model
- Innovative multi-port design provides installation flexibility
- 1/2" NPT inlets and outlets (side and back)
- Six (6) mounting holes (2 front & 4 side) for secure installation
- Natural gas (NG) or Liquid Propane (LP) - no conversion necessary

COMPLETELY MECHANICAL NO POWER REQUIRED

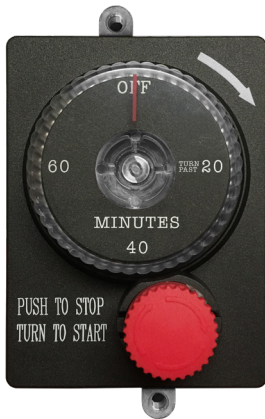

ESTOP1-0H

Mechanical timer with manual emergency shut off. 1 hour countdown timer

⚠ WARNING! | CALIFORNIA PROPOSITION 65

This product can expose you to Lead, which is known to the state of California to cause cancer and birth defects or other reproductive harm. (For more information, go to www.p65warnings.ca.gov)

SPECIFICATIONS

TYPICAL MAXIMUM CAPACITY

Natural Gas: 290,000 BTU/hr

Liquid Propane Gas: 430,000 BTU/hr

CSA RATED CAPACITY AT 1-INCH-H₂O PRESSURE DROP

165,000 BTU/hr

TYPICAL MAXIMUM CAPACITY IS BASED ON:

Nominal pressure supplied to inlet of E-Stop Timer while appliances are in-operation

NG: 7.0-Inches-H₂O

LP: 11.0-Inches-H₂O

Minimum rated appliance inlet pressure

NG: 3.5-Inches-H₂O

LP: 8.0-Inches-H₂O

ENCLOSURES E-STOP SOLD SEPARATELY

ESTOP-LC-KIT

Locking cabinet. Constructed of 304 stainless steel. Removable lock.

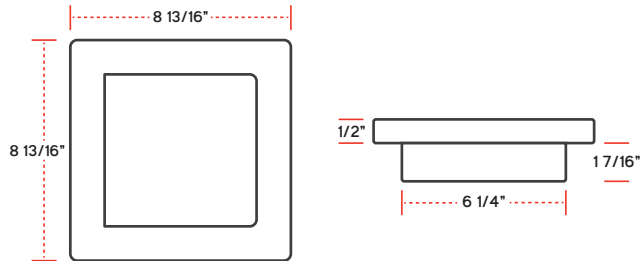

ESTOP-RM-KIT

Surface mount for the E-Stop. Constructed of 304 stainless steel.

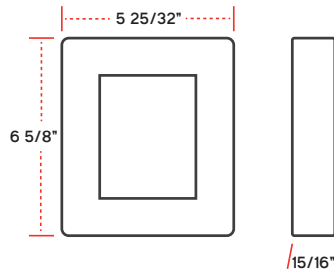

ESTOP-CP-KIT

Designed for use with architectural block & pavers. Expands from 8" to 12" wide to accommodate various block sizes.

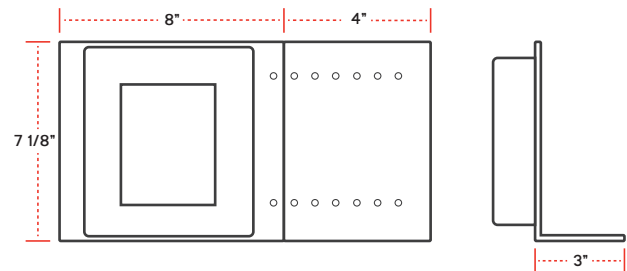

MOUNTING DIAGRAM

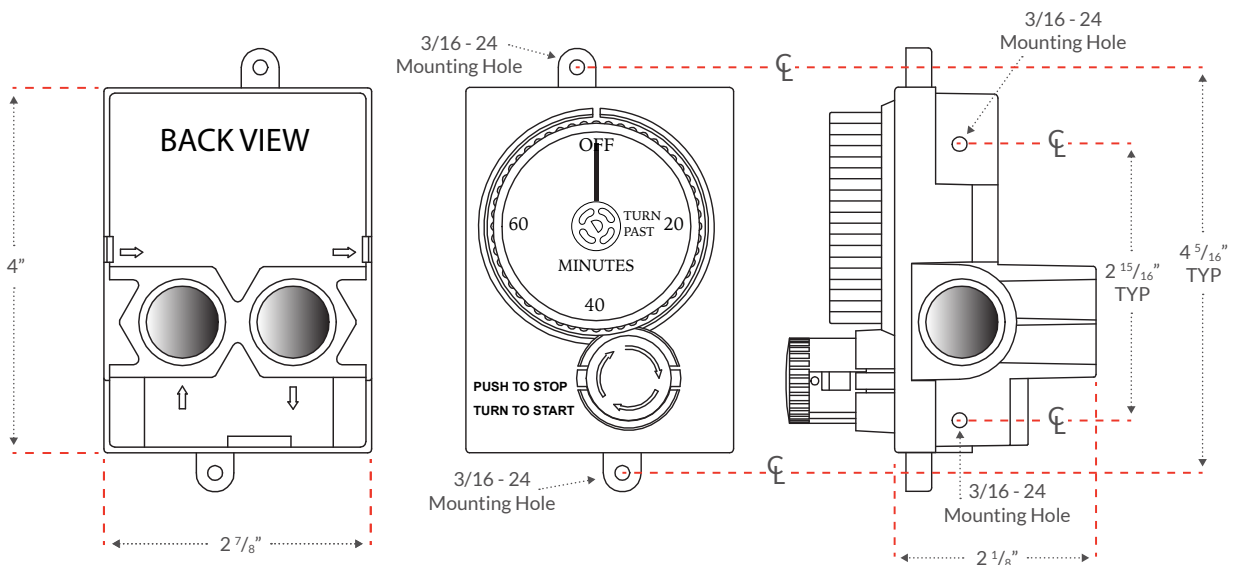

UNIVERSAL FAN KITS

F-180 SERIES | F-165 SERIES | FSCRF SERIES

ACCESSORIES





FK-180 SERIES

UNIVERSAL FAN KIT SYSTEMS

WARRANTY

2 Year limited warranty
on all fan kits

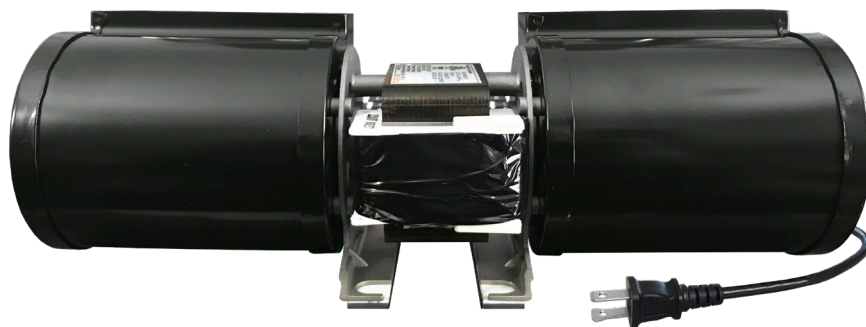

Dimensions: 12-3/4 inch Length x 4-3/8 inch High x 4-5/16 inch Deep

F-180-1

- Sealed ball bearing construction
- Quiet operation
- Increased CFM provides more air movement
- Heavy duty quality construction
- Dual fan blades
- Magnetic quick mount installation
- Power cord included
- Anti-vibration magnetic mounting strips
- ETL certified to CSA C22.2 & UL-1004



FK-180-ESC

- Sealed ball bearing construction
- Quiet operation
- Increased CFM provides more air movement
- Heavy duty quality construction
- Dual fan blades
- Magnetic quick mount installation
- Anti-vibration magnetic mounting strips
- ETL certified to CSA C22.2 & UL-1004
- Includes FK-ESC fan control



FK-180-RT

- Sealed ball bearing construction
- Quiet operation
- Increased CFM provides more air movement
- Heavy duty quality construction
- Dual fan blades
- Magnetic quick mount installation
- Anti-vibration magnetic mounting strips
- ETL certified to CSA C22.2 & UL-1004
- Includes Rheostat control and temperature sensor

FK-165 SERIES

UNIVERSAL FAN KIT SYSTEMS

WARRANTY

2 Year limited warranty
on all fan kits



Dimensions: 12-3/4 inch Length x 4 inch High x 3-1/2 inch Deep

F-165-1

- Low profile compact design fits most fireplaces
- Sealed ball bearing construction
- Quiet Operation
- Increased CFM provides more air movement
- Heavy duty quality construction
- Single cross flow fan blades
- Magnetic quick mount installation
- Power cord included
- Anti-vibration magnetic mounting strips
- ETL certified to CSA C22.2 & UL-1004



FK-165-ESC

- Low profile compact design fits most fireplaces
- Sealed ball bearing construction
- Quiet Operation
- Increased CFM provides more air movement
- Heavy duty quality construction
- Single cross flow fan blades
- Magnetic quick mount installation
- Anti-vibration magnetic mounting strips
- ETL certified to CSA C22.2 & UL-1004
- Includes FK-ESC fan control



FK-165-RT

- Low profile compact design fits most fireplaces
- Sealed ball bearing construction
- Quiet Operation
- Increased CFM provides more air movement
- Heavy duty quality construction
- Single cross flow fan blades
- Magnetic quick mount installation
- Anti-vibration magnetic mounting strips
- ETL certified to CSA C22.2 & UL-1004
- Includes Rheostat control temperature sensor

FIRE & FAN CONTROLS

ADD TO YOUR FAN KIT

GREAT FOR STOVES & INSERTS!

Introducing a brand new kit that combines our well-known Remotes with a Fan Speed Control Remote Receiver that will automatically turn your fireplace fan on and off when you turn the fireplace on or off.



1001-A-FSCRF

Automatically turns the fireplace fan on in 7 minutes from when the fireplace is turned on and turns the fan off in 12 minutes after the fireplace is turned off.

Battery operated easy-to-use on/off transmitter

110VAC plug-in receiver (no need to change receiver batteries)

“Set it and forget it” adjustable fan speed control receiver remembers your desired fan speed.

Four (4) fan speed settings and an Off setting.

Compatible with Millivolt and most Electronic Ignition controls.

BOX INCLUDES: Transmitter, Speed Control Receiver, Hardware Bag, Instructions



3301-A-FSCRF

Automatically turns the fireplace fan on in 7 minutes from when the fireplace is turned on and turns the fan off in 12 minutes after the fireplace is turned off.

“Set it and forget it” adjustable fan speed control receiver remembers your desired fan speed.

Four (4) fan speed settings and an Off setting.

Compatible with Millivolt or Electronic Ignition controls

Battery operated transmitter

Thermostatic control

Countdown timer

Adjustable swing temperature

110VAC plug-in receiver (no need to change receiver batteries)

Compatible with Millivolt and most Electronic Ignition controls

BOX INCLUDES: Transmitter, Speed Control Receiver, Wall Mount, Batteries, Hardware Bag, Instructions

FAN KIT ACCESSORIES

UNIVERSAL FAN KIT ACCESSORIES



FK-SPCONTROL

Rheostat variable fan speed control

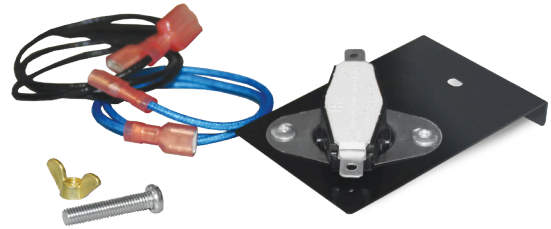

FK-SENSOR

Temperature sensor



FK-ESC

Multiple levels of fan speed control
Built in timer to activate fan
200 watt universal fan capacity
Two year warranty



FK-RTKIT

Rheostat variable fan speed control
Temperature sensor with wiring
One year warranty



ACF-10

10 inch female cord



ACM-36

36 inch male cord

FLEX LINES

Most popular sellers are shown
See our price list for our full offering of flex lines

T100 SERIES TRANQUILINE FLEX CONNECTOR



MODEL	DESCRIPTION
T100-9898-10	3/8" OD (1/4" ID) x 10", with 3/8" OD flare nuts
T100-9898-16	3/8" OD (1/4" ID) x 16", with 3/8" OD flare nuts
T100-9898-22	3/8" OD (1/4" ID) x 22", with 3/8" OD flare nuts
T100-9898-28	3/8" OD (1/4" ID) x 28", with 3/8" OD flare nuts
T100-9898-34	3/8" OD (1/4" ID) x 34", with 3/8" OD flare nuts

T102 SERIES TRANQUILINE FLEX CONNECTOR



MODEL	DESCRIPTION
T102-9898-10	3/8" OD (1/4" ID) x 10", with 3/8" OD flare nuts
T102-9898-16	3/8" OD (1/4" ID) x 16", with 3/8" OD flare nuts
T102-9898-22	3/8" OD (1/4" ID) x 22", with 3/8" OD flare nuts
T102-9898-28	3/8" OD (1/4" ID) x 28", with 3/8" OD flare nuts
T102-9898-34	3/8" OD (1/4" ID) x 34", with 3/8" OD flare nuts

T200 SERIES TRANQUILINE FLEX CONNECTOR



MODEL	DESCRIPTION
T200-9898-10	1/2" OD (3/8" ID) x 10", with 1/2" OD flare nuts
T200-9898-16	1/2" OD (3/8" ID) x 16", with 1/2" OD flare nuts
T200-9898-22	1/2" OD (3/8" ID) x 22", with 1/2" OD flare nuts
T200-9898-28	1/2" OD (3/8" ID) x 28", with 1/2" OD flare nuts
T200-9898-34	1/2" OD (3/8" ID) x 34", with 1/2" OD flare nuts

T202 SERIES TRANQUILINE FLEX CONNECTOR



MODEL	DESCRIPTION
T202-9898-10	1/2" OD (3/8" ID) x 10", with 1/2" OD flare nuts
T202-9898-16	1/2" OD (3/8" ID) x 16", with 1/2" OD flare nuts
T202-9898-22	1/2" OD (3/8" ID) x 22", with 1/2" OD flare nuts
T202-9898-28	1/2" OD (3/8" ID) x 28", with 1/2" OD flare nuts
T202-9898-34	1/2" OD (3/8" ID) x 34", with 1/2" OD flare nuts

⚠️ WARNING! | CALIFORNIA PROPOSITION 65

This product can expose you to Lead, which is known to the state of California to cause cancer and birth defects or other reproductive harm. (For more information, go to www.p65warnings.ca.gov)

FITTINGS

Most popular sellers are shown
See our price list for our full offering of fittings



U1-6C-S

3/8" OD FLARE X 3/8" MIP
(TAPPED 1/8" FIP)



U1-6D-S

3/8" OD FLARE X 1/2" MIP
(TAPPED 3/8" FIP)

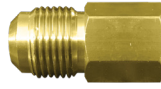

U3-6C-S

3/8" OD FLARE X 3/8" FIP

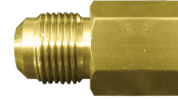

U3-6D-S

3/8" OD FLARE X 1/2" FIP

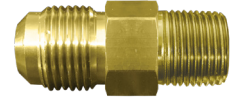

U1-8C-S

1/2" OD FLARE X 3/8" MIP
(TAPPED 1/4" FIP)

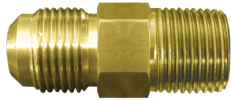

U1-8D-S

1/2" OD FLARE X 1/2" MIP
(TAPPED 3/8" FIP)

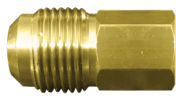

U3-8C-S

1/2" OD FLARE X 3/8" FIP

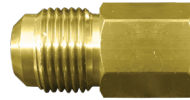

U3-8D-S

1/2" OD FLARE X 1/2" FIP

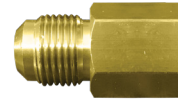

UR3-68

3/8" FEMALE FLARE TO 1/2"
MALE FLARE ADAPTER

⚠ WARNING! | CALIFORNIA PROPOSITION 65

This product can expose you to Lead, which is known to the state of California to cause cancer and birth defects or other reproductive harm. (For more information, go to www.p65warnings.ca.gov)

⚠ WARNING! | CALIFORNIA PROPOSITION 65

This product can expose you to Nickel, which is known to the state of California to cause cancer. (For more information, go to www.p65warnings.ca.gov)

GEMSTONES

JEWELRY FOR YOUR FIREPLACE

LARGE BROKEN GLASS



BLACK
GL-BLACK



COPPER
GL-COPPER



CRYSTAL
GL-CRYSTAL



LIGHT BLUE
GL-LIGHTBLUE

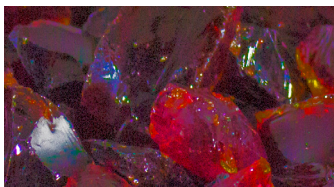

RED
GL-RED



SEABREEZE
GL-SEABREEZE

ALL GLASS IS SOLD
IN 5lb BAGS

Available in 8-Bag Master Cartons

SMALL REFLECTIVE GLASS



COBALT
GR-COBALT



PLATINUM
GR-PLAT

LARGE REFLECTIVE GLASS



BLACK
GRL-BLACK

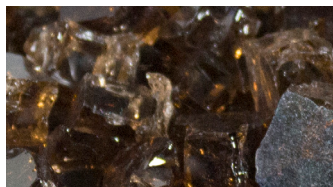

COPPER
GRL-COPPER

BEADED GLASS

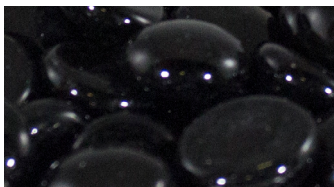

BLACK
GB-BLACK

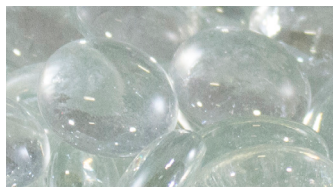

CLEAR
GB-CLEAR



WHITE
GB-WHITE

MAP POLICY

Skytech Products Group-Retail includes Skytech Control Systems (referred to as "SPG-Retail"). This division has developed a Minimum Advertised Pricing (MAP) policy (the "Policy") for all products sold by and purchased from SPG-Retail and through traditional and/or online retailers ("Products"). In an effort to protect the image and value of SPG-Retail products and to maintain fair and equitable promotional and sales activity among its distributors, dealers, retailers and other resellers (each, a "Retailer"), SPG-Retail has developed the MAP Policy effective immediately. The MAP Policy and its terms and conditions are as follows:

POLICY

Subject to certain exceptions set forth below, no Retailer shall, at any time, advertise or promote any SPG-Retail Products for sale or resale at a price lower than the MAP pricing established by SPG-Retail for such Products.

APPLICATION

The MAP Policy shall apply to all promotions and/or advertisements of any Products purchased from SPG-Retail that appear in any media form, including, without limitation, written or electronic flyers, posters, coupons, mailers, inserts, newspapers, magazines, catalogs, mail order catalogs, Internet, online, or similar electronic media, websites, email newsletters, email solicitations, television, radio, and/or public signage. The MAP Policy shall not apply to (a) any in-store advertising displayed by a Retailer, in-store displays, point-of-sale signs, hang tags or bar codes, or similar product price packaging which merely state the price of such product; (b) the promotion or advertisement of discontinued Product, so long as such Product is clearly marked as discontinued within said advertisement or promotion; and (c) the actual price at which any Products are sold to an individual consumer at or from a Retailer's physical location or via telephone.

OTHER TERMS AND CONDITIONS

MAP pricing is subject to change from time to time at the sole discretion of SPG-Retail and can be accessed by contacting SPG-Retail Divisions at (888) 672-8929, or by written request via email at info@skytechpg.com. It shall be the responsibility of all Retailers to remain current as to MAP Policy, pricing, and any changes thereto.

The MAP Policy shall apply to all Products sold to SPG-Retail distributors and resold thereby to any Internet or online dealers and retailers, and such distributors shall take all necessary steps to enforce the MAP Policy in connection with each and every such resale.

By accepting Products from SPG-Retail and in consideration of continued access to Products and the benefits realized as an SPG-Retail preferred, approved Retailer, each Retailer accepts and all Products they purchase from SPG-Retail shall be and remain subject to the MAP Policy as set forth herein. Should it be determined that any Product subject to the MAP Policy is or has been advertised or promoted at a price below the MAP pricing established for said Product by SPG-Retail at any time, the violating Retailer shall immediately take all steps necessary to cure said violation and bring its advertising, promotion, pricing and sales activity into compliance with the MAP Policy. SPG-Retail hereby, at any time, reserves the right to discontinue the shipment of Products to the violating Retailer and/or its distributor, and the right to terminate future sales of Products to said violating Retailer and/or its distributor, subject to the parties' respective financial and confidential obligations that shall survive such termination.

WARRANTY POLICY

Skytech Remote Control Warranty Replacement Policy

We understand that with our 5-year limited warranty products can sometimes fail whether they are new or still under warranty. However in order for us to provide the best possible service to you our policy is as follows:

If you feel you have a defective Skytech Remote Control and it is under warranty, that part must be returned to us for evaluation before a replacement will be sent. We will request you to send the product to us for evaluation providing us with your name, address, telephone number and short description of what is wrong with your remote. At the same time, if the remote is under warranty we request a copy or original receipt of date of purchase to ensure we can cover it under the warranty. In some cases we may assign you a Returned Materials Allocation (RMA) number. Once the evaluation has been conducted, if we find the remote control defective or it can be reworked we will send you a new replacement or your fully functioning original remote back to you at no charge.

If you cannot wait for the replacement part to be evaluated due to time constraints or certain situations you have the option to purchase a new remote. If you wish to have that replacement part expedited you will be charged for the shipping costs incurred.

Our Skytech Technical Support telephone line is 855.498.8324. If you have questions or concerns about the operation of your remote control please feel free to call us anytime between 8:00AM – 5:00PM EST.

ONLINE TOOLS

We strive to help our dealers and distributor be as informed as possible about our products. If you go our website you will find all of our instruction manuals for each individual product as well as helpful technical & customer service videos. Check back often as we are always adding and updating our catalog of online tools.





TECH SUPPORT	855.498.8324
SALES SUPPORT	888.699.6167
CANADA	877.472.3923
WEBSITE	SKYTECHPG.COM