

**MONTIGO®**

# Price Pages 2022



MONTIGO / DELRAY / DRISQ46NI-2 / NATURAL GAS

Prices shown in USD unless otherwise indicated  
and are subject to change without notice.

2022 - Released May 1 2022



# Ordering Process

Backup for continuous operation

**MUST ORDER: FIREPLACE, VENTING, FACEPLATE**

**A Choose the fireplace:**

30FIDNIS-01 TRADITIONAL	
Part	Code
Model equipped with Proflame 2 IPI [Elect Intermittent Pilot Ign] [3"x3" Co-linear Direct Vent]	NG LP
MUST ORDER BELOW LOGSET TO COMPLETE INS	
High Def. Logset REQUIRED Ships separate from fireplace	
Weight: 118lb Unit shipping	

## ORDERING YOUR FIREPLACE

The first step in the ordering process, generally deciding on a specific unit, selecting by NG or LP listing if applicable.

## ORDERING REQUIRED FIREPLACE COMPONENTS

After choosing the fireplace, sections marked with a letter in red contain components that are required to complete the order such as a required power vent or venting components.

**B Order venting components**

30FID VENTING COMPONENTS	
Part	
Duravent Termination - High Wind	
Duravent Co-linear to Co-axil Adaptor 3"x3"	
Duravent 3" Flex Linear Coupling [optional]	
35' Length of 3" aluminum flex, bulk, compressed	

## ORDERING OPTIONAL FIREPLACE COMPONENTS

Optional components and media are listed after the required components section, these are features and media that can improve the look and functionality, but are not necessary for operation of the unit.

Decorative media only required in linear logset

**Select optional components**

30FID COMPONENTS	
Part	
Natural Gas to Propane Conversion Kit	
2-Fan Kit	

## IMPORTANT NOTES

This document is for pricing and ordering purposes only. For installation or technical information, refer to the appropriate installation instructions and your local building codes.

Optional glass media is now priced out for one (1) bag, see unit descriptions for quantity required.

Consult your Montigo representative regarding models equipped for use at high altitudes [+4,500ft above sea level].

Shipping weights and dimensions are now listed in the unit description, these should be used as a general guideline and may not be exact.

# Q2 2022 Updates

## DISCONTINUED:

- Cultured Rocks
- All Divine Single Sided Fireplaces

## UPDATE:

- Heat management kits now available for all DelRay units

# Contents

<b>DISTINCTION SERIES</b> .....	<b>TAB 1</b>
Distinction Single Sided .....	3
Distinction See Through .....	4
<b>DELRAY SERIES</b> .....	<b>TAB 2</b>
DelRay Linear 36", 48" .....	5
DelRay Square 34" .....	6
DelRay Square 38" .....	7
DelRay Square 42" .....	8
DelRay Square 46" .....	9
<b>DIVINE SINGLE SIDED</b> .....	<b>TAB 3</b>
H34, HLB34, HLB34-2 .....	11
H38, HL38, HW38 .....	12
H42, HL42, HW42 .....	13
H36PV .....	14
<b>DIVINE MULTI SIDED</b> .....	<b>TAB 4</b>
Divine See Through .....	15
Divine Pier .....	16
Divine Bay .....	17
Divine Corner .....	18
<b>PHENOM</b> .....	<b>TAB 5</b>
L38FSD, L42FSD, L52FSD .....	19
P38, P42, P52 .....	20
PL38, PL42, PL52 .....	21
<b>OUTDOOR SERIES</b> .....	<b>TAB 6</b>
Mahana .....	23
Divine Ventless Outdoor .....	24
Divine ST Ventless Outdoor .....	25
<b>ILLUME</b> .....	<b>TAB 7</b>
30FID .....	27
34FID .....	28
<b>EXEMPLAR</b> .....	<b>TAB 8</b>
Exemplar Single Sided .....	29
Exemplar See Through .....	30
Exemplar RP620 .....	31
Exemplar Indoor Outdoor .....	32
Exemplar Pier .....	33
<b>VENTING</b> .....	<b>TAB 9</b>
4"/7" Direct Vent Components .....	35
4"/7" Direct Vent Components Cont. ....	36
5"/8" Direct Vent Components .....	37
5"/8" Direct Vent Components Cont. ....	38
5"/10" Direct Vent Components .....	39
Heat Management .....	40
Vent Kits .....	41
<b>POWER VENTING</b> .....	<b>TAB 10</b>
External Wall Mount Power Vent .....	43
External Roof Mount Power Vent .....	44
Flush Louvered Inline Power Vent - 200 .....	45
Wall Mount Power Vent - 300 .....	46
Roof Mount Power Vent - 300 .....	47
Flush Louvered Power Vent - 300 .....	48
Flush Louvered Inline Power Vent - 300 .....	49
<b>MISCELLANEOUS</b> .....	<b>TAB 11</b>
Designer Burner Accessories .....	51
Miscellaneous Components .....	52

# Distinction Single Sided



D6315 with optional driftwood and speckled stones shown

- Concealed burner with Ice fireglass, multi-function remote control, remote Hi-Lo flame control, remote controlled fans, Invisimesh screen, black reflective glass, multicolor LED uplighting, battery backup
- Certain size models meet requirements for efficiency rebates
- Optional heat distribution kits

**MUST ORDER:** Fireplace

## A Select the fireplace:

D3615NI-2			
35,000 BTU NG/LP Model with Proflame 2 IPI 5"/8" venting	NG	D3615NI-2	\$4,781.00
D3615NI-2 NG to LP Conversion Kit	GCA015		\$142.00
Supplied with 2 bags of Ice fireglass. [HW1157] Shipping weight: 460lb Shipping length: 60" Width: 31" Height: 52"			
D4815NI-2			
40,000 BTU NG/LP Model with Proflame 2 IPI 5"/8" venting	NG	D4815NI-2	\$6,074.00
D4815NI-2 NG to LP Conversion Kit	GCA017		\$142.00
Supplied with 3 bags of Ice fireglass. [HW1157] Shipping weight: 556lb Shipping length: 72" Width: 31" Height: 52"			
D6315NI-2			
50,000 BTU NG/LP Model with Proflame 2 IPI 5"/8" venting	NG	D6315NI-2	\$11,788.00
D6315NI-2 NG to LP Conversion Kit	GCA009		\$142.00
Supplied with 4 bags of Ice fireglass. [HW1157] Shipping weight: 516lb Shipping length: 82½" Width: 23" Height: 45"			
D7215NI-2			
57,000 BTU NG/LP Model with Proflame 2 IPI 5"/8" venting	NG	D7215NI-2	\$13,142.00
D7215NI-2 NG to LP Conversion Kit	GCA013		\$142.00
Supplied with 5 bags of Ice fireglass. [HW1157] Shipping weight: 780lb Shipping length: 95½" Width: 32" Height: 53½"			

## Optional venting components

### COMPATIBLE VENTING

Distinction series	5"/8" Direct Vent Components - Page 37
Distinction (with PVA5487 adapter)	4"/7" Direct Vent Components - Page 35

### COMPATIBLE POWER VENTS

Part	Reference
4"/7" Power Vent Systems	External Wall Mount Power Vent - Page 43 External Roof Mount Power Vent - Page 44 Flush Louvered Inline Power Vent - 200 - Page 45

## Optional components

### D SERIES ACCESSORIES

Wall Mounted Proflame 2 Remote	REC1493	\$261.00
Reduces 5"/8" venting to 4"/7" (male/female connectors)	PVA5487	\$121.00

## Optional decorative media

Part	Code	List price
Firestones [D3615 2 bags, D4815 3 bags, D6315 4 bags, D7215 5 bags]	HW****	\$63.00
Fireglass [D3615 2 bags, D4815 3 bags, D6315 4 bags, D7215 5 bags]	HW****	\$53.00
Ice Fireglass [D3615 2 bags, D4815 3 bags, D6315 4 bags, D7215 5 bags]	HW1157	\$31.00
Firebeads [D3615 2 bags, D4815 3 bags, D6315 4 bags, D7215 5 bags]	HW****	\$22.00
D3615 Speckled Stones	RR150SS	\$232.00
D3615 Driftwood Logset [Installation requires both logsets]	LGS59	\$271.00
	LGS60	\$297.00
D4815 Speckled Stones	RR200SS	\$337.00
D4815 Driftwood Logset [Installation requires all 3 logsets]	LGS57	\$280.00
	LGS59	\$271.00
	LGS61	\$214.00
D6315 Speckled Stones	RR450SS	\$748.00
D6315 Driftwood Logset [Installation requires both logsets]	LGS58	\$330.00
	LGS59	\$271.00
D7215 Speckled Stones	RR450SS	\$748.00
D7215 Driftwood Logset [Installation requires all 3 logsets]	LGS58	\$330.00
	LGS59	\$271.00
	LGS57	\$280.00
D3615 Ash Fluted Liner	DBK36AF	\$244.00
D3615 Tuscan Fluted Liner	DBK36TF	\$244.00
D4815 Ash Fluted Liner	DBK48AF	\$312.00
D4815 Tuscan Fluted Liner	DBK48TF	\$312.00
D6315 Ash Fluted Liner	DBK63AF	\$383.00
D6315 Tuscan Fluted Liner	DBK63TF	\$383.00
D7215 Ash Fluted Liner	DBK72AF	\$423.00
D7215 Tuscan Fluted Liner	DBK72TF	\$423.00
D3613 1" Adjustable Trim Kit†	DLT36	\$134.00
D3613 1" Adjustable Trim Kit - extra deep‡	DLT36-2	\$146.00
D4813 1" Adjustable Trim Kit†	DLT48	\$157.00
D4813 1" Adjustable Trim Kit - extra deep‡	DLT48-2	\$171.00
D6313 1" Adjustable Trim Kit†	DLT63	\$186.00
D6313 1" Adjustable Trim Kit - extra deep‡	DLT63-2	\$200.00
D7213 1" Adjustable Trim Kit†	DLT72	\$200.00
D7213 1" Adjustable Trim Kit - extra deep‡	DLT72-2	\$223.00

†Standard kit for up to 11/16" deep facing materials

‡Extra deep kit for 1½"-2" deep facing materials

# Distinction See Through



- Concealed burner with Ice fireglass, multi-function remote control, remote Hi-Lo flame control, Invisimesh screen, black reflective glass, multicolor LED uplighting, battery backup
- Certain size models meet requirements for efficiency rebates
- Optional heat distribution kits

**MUST ORDER:** Fireplace



D7215ST shown

## A Select the fireplace:

D3615STNI-2			
35,000 BTU NG/LP Model with Proflame 2 IPI 5"/8" venting	NG	D3615STNI-2	\$6,113.00
D3615STNI-2 NG to LP Conversion Kit	GCA015		\$142.00
Supplied with 2 bags of Ice fireglass. [HW1157] Shipping weight: 460lb Shipping length: 60" Width: 31" Height: 52"			
D4815STNI-2			
40,000 BTU NG/LP Model with Proflame 2 IPI 5"/8" venting	NG	D4815STNI-2	\$7,679.00
D4815STNI-2 NG to LP Conversion Kit	GCA017		\$142.00
Supplied with 3 bags of Ice fireglass. [HW1157] Shipping weight: 556lb Shipping length: 72" Width: 31" Height: 52"			
D6315STNI-2			
50,000 BTU NG/LP Model with Proflame 2 IPI 5"/8" venting	NG	D6315STNI-2	\$14,539.00
D6315STNI-2 NG to LP Conversion Kit	GCA009		\$142.00
Supplied with 4 bags of Ice fireglass. [HW1157] Shipping weight: 516lb Shipping length: 82½" Width: 23" Height: 45"			
D7215STNI-2			
57,000 BTU NG/LP Model with Proflame 2 IPI 5"/8" venting	NG	D7215STNI-2	\$16,065.00
D7215STNI-2 NG to LP Conversion Kit	GCA013		\$142.00
Supplied with 5 bags of Ice fireglass. [HW1157] Shipping weight: 780lb Shipping length: 95½" Width: 32" Height: 53½"			

## Optional venting components

### COMPATIBLE VENTING

Distinction series	5"/8" Direct Vent Components - Page 37
Distinction (with PVA5487 adapter)	4"/7" Direct Vent Components - Page 35

### COMPATIBLE POWER VENTS

Part	Reference
4"/7" Power Vent Systems	External Wall Mount Power Vent - Page 43 External Roof Mount Power Vent - Page 44 Flush Louvered Inline Power Vent - 200 - Page 45

## Optional components

### D SERIES ACCESSORIES

Wall Mounted Proflame 2 Remote	REC1493	\$261.00
Reduces 5"/8" venting to 4"/7" (male/female connectors)	PVA5487	\$121.00

## Optional decorative media:

Part	Code	List price
Firestones [D3615 2 bags, D4815 3 bags, D6315 4 bags, D7215 5 bags]	HW****	\$63.00
Fireglass [D3615 2 bags, D4815 3 bags, D6315 4 bags, D7215 5 bags]	HW****	\$53.00
Ice Fireglass [D3615 2 bags, D4815 3 bags, D6315 4 bags, D7215 5 bags]	HW1157	\$31.00
Firebeads [D3615 2 bags, D4815 3 bags, D6315 4 bags, D7215 5 bags]	HW****	\$22.00
D3615 Speckled Stones	RR150SS	\$232.00
D3615 Driftwood Logset [D3615ST Requires 2 LGS59 kits]	LGS59	\$271.00
D4815 Speckled Stones	RR200SS	\$337.00
D4815 Driftwood Logset [D4815ST Requires 2 LGS59 kits]	LGS59	\$271.00
D6315 Speckled Stones	RR450SS	\$748.00
D6315 Driftwood Logset [Installation requires both logsets]	LGS58 LGS59	\$330.00 \$271.00
D7215 Speckled Stones	RR450SS	\$748.00
D7215ST Driftwood Logset [Installation requires both logsets]	LGS58 LGS59	\$330.00 \$271.00
D3615ST Ash Fluted Liner	DBKAFST	\$84.00
D3615ST Tuscan Fluted Liner	DBKTFST	\$84.00
D4815ST Ash Fluted Liner	DBKAFST	\$84.00
D4815ST Tuscan Fluted Liner	DBKTFST	\$84.00
D6315ST Ash Fluted Liner	DBK63AFST	\$99.00
D6315ST Tuscan Fluted Liner	DBK63TFST	\$99.00
D7215ST Ash Fluted Liner	DBKAFST	\$84.00
D7215ST Tuscan Fluted Liner	DBKTFST	\$84.00
D3613 1" Adjustable Trim Kit†	DLT36	\$134.00
D3613 1" Adjustable Trim Kit - extra deep‡	DLT36-2	\$146.00
D4813 1" Adjustable Trim Kit†	DLT48	\$157.00
D4813 1" Adjustable Trim Kit - extra deep‡	DLT48-2	\$171.00
D6313 1" Adjustable Trim Kit†	DLT63	\$186.00
D6313 1" Adjustable Trim Kit - extra deep‡	DLT63-2	\$200.00
D7213 1" Adjustable Trim Kit†	DLT72	\$200.00
D7213 1" Adjustable Trim Kit - extra deep‡	DLT72-2	\$223.00

Trim kits will cover only one facing trim of the fireplace

†Standard kit for up to 11/16" deep facing materials  
‡Extra deep kit for 1½"-2" deep facing materials

Note: fans not available.

# DelRay Linear 36", 48"



DelRay DRL3613NI-2 with Amber firestones

- DRL\*\*13NI-2 - Concealed burner with Ice fireglass, multi-function remote control, remote controlled fans, Invisimesh screen, black reflective glass, halogen downlighting, battery backup
- Optional heat distribution kits
- DRL\*\*13NI - linear contemporary burner, Ice fireglass, comes w/ Proflame 2 BASIC
- Simple field conversion kit
- Thin 14¼" framing depth and 4"7" vent
- Finish materials right up to the fireplace edge for a clean finish
- Mobile home compatible

**MUST ORDER:** Fireplace

## A Select the fireplace:

DRL3613NI			
16,000 BTU NG model with Proflame 2 Basic IPI 4"7" venting	NG	DRL3613NI	\$2,426.00
DRL36 NG to Propane Conversion Kit	GCA010		\$95.00
Supplied with 2 bags of Ice fireglass. [HW1157] Shipping weight: 127lb Shipping length: 46" Width: 14" Height: 29"			

DRL3613NI-2 FULL LOAD			
16,000 BTU NG model equipped with Proflame 2 IPI, multi-function remote control, remote controlled fans, Invisimesh screen, black reflective glass, halogen downlighting, battery backup, 4"7" venting	NG	DRL3613NI-2	\$3,471.00
DRL36 NG to Propane Conversion Kit	GCA010		\$95.00
Supplied with 2 bags of Ice fireglass. [HW1157] Shipping weight: 153lb Shipping length: 46" Width: 14" Height: 29"			

DRL4813NI			
21,000 BTU NG model with Proflame 2 Basic IPI 4"7" venting	NG	DRL4813NI	\$3,192.00
DRL48 NG to Propane Conversion Kit	GCA019		\$95.00
Supplied with 3 bags of Ice fireglass. [HW1157] Shipping weight: 165lb Shipping length: 57" Width: 14" Height: 29"			

DRL4813NI-2 FULL LOAD			
21,000 BTU NG model equipped with Proflame 2 IPI, multi-function remote control, remote controlled fans, Invisimesh screen, black reflective glass, halogen downlighting, battery backup, 4"7" venting	NG	DRL4813NI-2	\$4,561.00
DRL48 NG to Propane Conversion Kit	GCA019		\$95.00
Supplied with 3 bags of Ice fireglass. [HW1157] Shipping weight: 190lb Shipping length: 57" Width: 14" Height: 29"			

## Optional venting components:

### COMPATIBLE VENTING

Unit	Reference
DelRay units	4"7" Direct Vent Components - Page 35

## Optional components:

### DELRAY UNIVERSAL ACCESSORIES

Part	Code	List price
DRL3613 1" Adjustable Trim Kit (For up to 11/16 deep facing materials)	DRLT36	\$123.00
DRL3613 1" Adjustable Trim Kit (For 1½"-2" deep facing materials)	DRLT36-2	\$172.00
DRL4813 1" Adjustable Trim Kit (For up to 11/16 deep facing materials)	DRLT48	\$146.00
DRL4813 1" Adjustable Trim Kit (For 1½"-2" deep facing materials)	DRLT48-2	\$206.00

### DELRAY FULL LOAD ACCESSORIES

Wall Mounted Proflame 2 Remote	REC1493	\$261.00
--------------------------------	---------	----------

### DELRAY BASIC ACCESSORIES

Emergency Battery Back-up	AF40BP	\$25.00
Remote - [on/off only]	RX40	\$312.00
Remote - [on/off + thermostatic control]	RX60	\$398.00
DelRay Fan Kit - [on/off, heat sensor fans, manual fan speed control]	DRFK1	\$383.00
DRL3613 Reflective Glass Panel Kit	RBGDRL36	\$500.00
DRL4813 Reflective Glass Panel Kit	RBGDRL48	\$693.00
DRL3613 Invisimesh Screen	SCRIDRL36	\$293.00
DRL4813 Invisimesh Screen	SCRIDRL48	\$390.00

## Optional decorative media:

### MEDIA OPTIONS

Part	Code	List price
DRL36 Speckled Stones	RR150SS	\$232.00
DRL48 Speckled Stones	RR200SS	\$337.00
DRL36 Driftwood Logset [Incl. embers]	LGS76	\$223.00
DRL48 Driftwood Logset [Incl. embers]	LGS77	\$284.00
Firestones [DRL3613 2 bags, DRL4813 3 bags]	HW****	\$63.00
Fireglass [DRL3613 2 bags, DRL4813 3 bags]	HW****	\$53.00
Ice Fireglass [DRL3613 2 bags, DRL4813 3 bags]	HW1157	\$31.00
Firebeads [DRL3613 2 bags, DRL4813 3 bags]	HW****	\$22.00

Flame turndown not available on basic or full load units  
 Ω Mobile home compatible units can be ordered by adding an (MH) to the end of the unit order code

# DelRay Square 34"



- DRSQNI-2 - Concealed universal burner, multi-function remote control, remote Hi-Lo flame control, remote controlled fans, Invisimesh screen, battery backup, halogen downlighting
- DRSQNI - Comes w/ Proflame 2 BASIC, concealed universal burner, manual Hi-Lo flame control
- Mobile home compatible
- 4"/7" vent
- Finish materials right up to the fireplace edge for a clean finish
- Optional heat distribution kits

**MUST ORDER:** A Fireplace B Media System

## A Select the fireplace:

DRSQ34NI PRICING & AVAILABILITY COMING SOON		
Part	Code	List price
XX,XXX BTU NG model with Proflame 2 BASIC IPI 4"/7" venting	NG DRSQ34NI	
	LP GCA020	
<b>MUST ORDER MEDIA SYSTEM TO COMPLETE INSTALLATION</b>		
Shipping weight: xxxlb Shipping length: XX" Width: XX" Height: XX"		

DRSQ34NI-2 FULL LOAD PRICING & AVAILABILITY COMING SOON		
Part	Code	List price
XX,XXX BTU NG model equipped with Proflame 2 IPI, multi-function remote control, remote Hi-Lo flame control, remote controlled fans, Invisimesh screen, battery backup, halogen downlighting, 4"/7" venting	NG DRSQ34NI-2	
	LP GCA021	
<b>MUST ORDER MEDIA SYSTEM TO COMPLETE INSTALLATION</b>		
Shipping weight: xxxlb Shipping length: XX" Width: XX" Height: XX"		

## Optional venting components:

### COMPATIBLE VENTING

Unit	Reference
DelRay units	4"/7" Direct Vent Components - Page 35

### DELRAY LINERS

Part	Code	List price
Grey Herringbone	DRSQBK34GH	
Ash Fluted	DRSQBK34AF	
Grey LedgeStone	DRSQBK34GL	
Vintage Brown Brick	DRSQBK34VB	
Tan Brick	DRSQBK34TB	
Red Brick	DRSQBK34RB	
Black Reflective Glass	RBGDRSQ34	

## B Select a media system:

DELRAY TRADITIONAL SETS		
Part	Code	List price
Driftwood	LGSDW34	
Birch	LGSBI34	
Split Oak	LGSSO34	
All traditional scenes come with a logset and Black Coal fuelbed and embers		

DELRAY CONTEMPORARY SCENES		
Part	Code	List price
Winter contemporary scene - [Alabaster firestones, white rocks, ceramic chips, embers]	CSW34	
Twilight contemporary scene - [Obsidian firestones, black rocks, ceramic chips, embers]	CST34	
Beach contemporary scene - [Speckled stones, mixed rocks, embers]	CSB34	

MEDIA OPTIONS		
Part	Code	List price
DelRay Speckled Stones		
Red Coals	HW1266	\$63.00
Grey Coals	HW1265	\$63.00
DelRay Glass Media		Designer Burner Accessories - Page 51

## Optional components:

### DELRAY UNIVERSAL ACCESSORIES

Part	Code	List price
DRSQ34 1" Adjustable Trim Kit†	DRSQT34	
DRSQ34 1" Adjustable Trim Kit - extra deep‡	DRSQT34-2	

†Standard kit for up to 11/16" deep facing materials  
‡Extra deep kit for 1½"-2" deep facing materials

### DELRAY FULL LOAD ACCESSORIES

Wall Mounted Proflame 2 Remote	REC1493	\$261.00
--------------------------------	---------	----------

### DELRAY BASIC ACCESSORIES

Emergency Battery Back-up	AF40BP	\$25.00
Remote - [on/off only]	RX40	\$312.00
Remote - [on/off + thermostatic control]	RX60	\$398.00
DelRay Square Fan Kit - [on/off, heat sensor fans, manual fan speed control]	DRFK2	\$383.00
DRSQ34 Invisimesh Screen	SCRIDRSQ34	

Ω Mobile home compatible units can be ordered by adding an (MH) to the end of the unit order code

# DelRay Square 38"



DelRay DRSQ38NI-2 with Split Oak logset and Grey Ledgestone liner

- DRSQNI-2 - Concealed universal burner, multi-function remote control, remote Hi-Lo flame control, remote controlled fans, Invisimesh screen, battery backup, halogen downlighting
- DRSQNI - Comes w/ Proflame 2 BASIC, concealed universal burner, manual Hi-Lo flame control
- Mobile home compatible
- Convertible to 4"/7"
- Finish materials right up to the fireplace edge for a clean finish
- Optional heat distribution kits

**MUST ORDER:** **A** Fireplace **B** Media System

## A Select the fireplace:

DRSQ38NI			
Part	Code		List price
20,500 BTU NG model with Proflame 2 BASIC IPI 5"/8" venting	NG	DRSQ38NI	\$2,759.00
	LP	GCA020	\$95.00
<b>MUST ORDER MEDIA SYSTEM TO COMPLETE INSTALLATION</b>			
Shipping weight: 127lb Shipping length: 46" Width: 14" Height: 29"			

DRSQ38NI-2 FULL LOAD			
Part	Code		List price
24,000 BTU NG model equipped with Proflame 2 IPI, multi-function remote control, remote Hi-Lo flame control, remote controlled fans, Invisimesh screen, battery backup, halogen downlighting, 5"/8" venting	NG	DRSQ38NI-2	\$3,914.00
	LP	GCA021	\$95.00
<b>MUST ORDER MEDIA SYSTEM TO COMPLETE INSTALLATION</b>			
Shipping weight: 153lb Shipping length: 46" Width: 14" Height: 29"			

## Optional venting components:

### COMPATIBLE VENTING

Reduced to 4/7	4"/7" Direct Vent Components - Page 35
DelRay DRSQ38	5"/8" Direct Vent Components - Page 37

## Optional liners & optional media:

### DELRAY LINERS

Part	Code	List price
Grey Herringbone	DRSQBK38GH	\$305.00
Ash Fluted	DRSQBK38AF	\$305.00
Grey Ledgestone	DRSQBK38GL	\$305.00
Vintage Brown Brick	DRSQBK38VB	\$305.00
Tan Brick	DRSQBK38TB	\$305.00
Red Brick	DRSQBK38RB	\$305.00
Black Reflective Glass	RBGDRSQ38	\$502.00

## B Select a media system:

### DELRAY TRADITIONAL SETS

Part	Code	List price
Driftwood	LGSDW38	\$251.00
Birch	LGSBI38	\$251.00
Split Oak	LGSSO38	\$251.00

All traditional scenes come with a logset and Black Coal fuelbed and embers

### DELRAY CONTEMPORARY SCENES

Part	Code	List price
Winter contemporary scene - [Alabaster firestones, white rocks, ceramic chips, embers]	CSW38	\$251.00
Twilight contemporary scene - [Obsidian firestones, black rocks, ceramic chips, embers]	CST38	\$251.00
Beach contemporary scene - [Speckled stones, mixed rocks, embers]	CSB38	\$251.00

### MEDIA OPTIONS

DelRay Speckled Stones	RR150SS	\$232.00
Red Coals	HW1266	\$63.00
Grey Coals	HW1265	\$63.00
DelRay Glass Media [Requires 2 bags to complete installation]	Designer Burner Accessories - Page 51	

## Optional components:

### DELRAY UNIVERSAL ACCESSORIES

Part	Code	List price
DRSQ38 1" Adjustable Trim Kit†	DRSQT38	\$137.00
DRSQ38 1" Adjustable Trim Kit - extra deep‡	DRSQT38-2	\$195.00

†Standard kit for up to 11/16" deep facing materials

‡Extra deep kit for 1½"-2" deep facing materials

### DELRAY FULL LOAD ACCESSORIES

Wall Mounted Proflame 2 Remote	REC1493	\$261.00
--------------------------------	---------	----------

### DELRAY BASIC ACCESSORIES

Emergency Battery Back-up	AF40BP	\$25.00
Remote - [on/off only]	RX40	\$312.00
Remote - [on/off + thermostatic control]	RX60	\$398.00
DelRay Square Fan Kit - [on/off, heat sensor fans, manual fan speed control]	DRFK2	\$383.00
DRSQ38 Invisimesh Screen	SCRIDRSQ38	\$368.00

Ω Mobile home compatible units can be ordered by adding an (MH) to the end of the unit order code

# DelRay Square 42"



- DRSQNI-2 - Concealed universal burner, multi-function remote control, remote Hi-Lo flame control, remote controlled fans, Invisimesh screen, battery backup, halogen downlighting
- DRSQNI - Comes w/ Proflame 2 BASIC, concealed universal burner, manual Hi-Lo flame control
- Mobile home compatible
- Finish materials right up to the fireplace edge for a clean finish
- Optional heat distribution kits



DelRay DRSQ42NI-2 with Driftwood logset and Red Brick liner

**MUST ORDER:** **A** Fireplace **B** Media System

## A Select the fireplace:

DRSQ42NI			
Part	Code		List price
32,500 BTU NG model with Proflame 2 BASIC IPI 5"/8" venting	NG	DRSQ42NI	\$4,568
	LP	GCA026	\$105.00
<b>MUST ORDER MEDIA SYSTEM TO COMPLETE INSTALLATION</b>			
Shipping weight: 242lb Shipping length: 55" Width: 24" Height: 46"			

DRSQ42NI-2 FULL LOAD			
Part	Code		List price
32,500 BTU NG model equipped with Proflame 2 IPI, multi-function remote control, remote Hi-Lo flame control, remote controlled fans, Invisimesh screen, battery backup, halogen downlighting, 5"/8" venting	NG	DRSQ42NI-2	\$5,296
	LP	GCA027	\$105.00
<b>MUST ORDER MEDIA SYSTEM TO COMPLETE INSTALLATION</b>			
Shipping weight: 257lb Shipping length: 55" Width: 24" Height: 46"			

## Optional venting components:

### COMPATIBLE VENTING

DelRay DRSQ42	5"/8" Direct Vent Components - Page 37
---------------	--

## Optional liners & optional media:

### DELRAY LINERS

Part	Code	List price
Grey Herringbone	DRSQBK42GH	\$335.00
Ash Fluted	DRSQBK42AF	\$335.00
Grey LedgeStone	DRSQBK42GL	\$335.00
Vintage Brown Brick	DRSQBK42VB	\$335.00
Tan Brick	DRSQBK42TB	\$335.00
Red Brick	DRSQBK42RB	\$335.00
Black Reflective Glass	RBGDRSQ42	\$552.00

## B Select a media system:

### DELRAY TRADITIONAL SETS

Part	Code	List price
Driftwood	LGSDW4	\$278.00
Birch	LGSBI4	\$278.00
Split Oak	LGSSO4	\$278.00

All traditional scenes come with a logset and Black Coal fuelbed and embers

### DELRAY CONTEMPORARY SCENES

Part	Code	List price
Winter contemporary scene - [Alabaster firestones, white rocks, ceramic chips, embers]	CSW42	\$278.00
Twilight contemporary scene - [Obsidian firestones, black rocks, ceramic chips, embers]	CST42	\$278.00
Beach contemporary scene - [Speckled stones, mixed rocks, embers]	CSB42	\$370.00

### MEDIA OPTIONS

DelRay Speckled Stones	RR250SS	\$422.00
Red Coals	HW1266	\$63.00
Grey Coals	HW1265	\$63.00
DelRay Glass Media [Requires 3 bags to complete installation]	Designer Burner Accessories - Page 51	

## Optional components:

### DELRAY UNIVERSAL ACCESSORIES

Part	Code	List price
DRSQ42 1" Adjustable Trim Kit†	DRSQ42	\$149.00
DRSQ42 1" Adjustable Trim Kit - extra deep‡	DRSQ42-2	\$214.00

†Standard kit for up to 11/16" deep facing materials

‡Extra deep kit for 1½"-2" deep facing materials

### DELRAY FULL LOAD ACCESSORIES

Wall Mounted Proflame 2 Remote	REC1493	\$261.00
--------------------------------	---------	----------

### DELRAY BASIC ACCESSORIES

Emergency Battery Back-up	AF40BP	\$25.00
Remote - [on/off only]	RX40	\$312.00
Remote - [on/off + thermostatic control]	RX60	\$398.00
DelRay Square Fan Kit - [on/off, heat sensor fans, manual fan speed control]	DRFK2	\$383.00
DRSQ42 Invisimesh Screen	SCRIDRSQ42	\$402.00

Ω Mobile home compatible units can be ordered by adding an (MH) to the end of the unit order code



# DelRay Square 46"



DelRay DRSQ46NI-2 with Birch logset and Ash Fluted liner

- DRSQNI-2 - Concealed universal burner, multi-function remote control, remote Hi-Lo flame control, remote controlled fans, Invisimesh screen, battery backup, halogen downlighting
- DRSQNI - Comes w/ Proflame 2 BASIC, concealed universal burner, manual Hi-Lo flame control
- Mobile home compatible
- Finish materials right up to the fireplace edge for a clean finish
- Optional heat distribution kits

**MUST ORDER:** **A** Fireplace **B** Media System

## A Select the fireplace:

DRSQ46NI			
Part	Code		List price
40,000 BTU NG model with Proflame 2 BASIC IPI 5"/8" venting	NG	DRSQ46NI	\$4,997
	LP	GCA023	\$115.00
<b>MUST ORDER MEDIA SYSTEM TO COMPLETE INSTALLATION</b>			
Shipping weight: 279lb Shipping length: 55½" Width: 24½" Height: 46"			

DRSQ46NI-2 FULL LOAD			
Part	Code		List price
40,000 BTU NG model equipped with Proflame 2 IPI, multi-function remote control, remote Hi-Lo flame control, remote controlled fans, Invisimesh screen, battery backup, halogen downlighting, 5"/8" venting	NG	DRSQ46NI-2	\$5,798
	LP	GCA024	\$115.00
<b>MUST ORDER MEDIA SYSTEM TO COMPLETE INSTALLATION</b>			
Shipping weight: 289lb Shipping length: 55½" Width: 24½" Height: 46"			

## Optional venting components:

### COMPATIBLE VENTING

DelRay DRSQ46	5"/8" Direct Vent Components - Page 37
---------------	--

## Optional liners & optional media:

### DELRAY LINERS

Part	Code	List price
Grey Herringbone	DRSQBK46GH	\$368.00
Ash Fluted	DRSQBK46AF	\$368.00
Grey LedgeStone	DRSQBK46GL	\$368.00
Vintage Brown Brick	DRSQBK46VB	\$368.00
Tan Brick	DRSQBK46TB	\$368.00
Red Brick	DRSQBK46RB	\$368.00
Black Reflective Glass	RBGDRSQ46	\$607.00

## B Select a media system:

### DELRAY TRADITIONAL SETS

Part	Code	List price
Driftwood	LGSDW4	\$278.00
Birch	LGSBI4	\$278.00
Split Oak	LGSSO4	\$278.00
All traditional scenes come with a logset and Black Coal fuelbed and embers		

### DELRAY CONTEMPORARY SCENES

Part	Code	List price
Winter contemporary scene - [Alabaster firestones, white rocks, ceramic chips, embers]	CSW46	\$339.00
Twilight contemporary scene - [Obsidian firestones, black rocks, ceramic chips, embers]	CST46	\$339.00
Beach contemporary scene - [Speckled stones, mixed rocks, embers]	CSB46	\$431.00

### MEDIA OPTIONS

DelRay Speckled Stones	RR300SS	\$496.00
Red Coals	HW1266	\$63.00
Grey Coals	HW1265	\$63.00
DelRay Glass Media [Requires 3 bags to complete installation]	Designer Burner Accessories - Page 51	

## Optional components:

### DELRAY UNIVERSAL ACCESSORIES

Part	Code	List price
DRSQ46 1" Adjustable Trim Kit†	DRSQ46	\$165.00
DRSQ46 1" Adjustable Trim Kit - extra deep‡	DRSQ46-2	\$235.00

†Standard kit for up to 11/16" deep facing materials  
‡Extra deep kit for 1½"-2" deep facing materials

### DELRAY FULL LOAD ACCESSORIES

Wall Mounted Proflame 2 Remote	REC1493	\$261.00
--------------------------------	---------	----------

### DELRAY BASIC ACCESSORIES

Emergency Battery Back-up	AF40BP	\$25.00
Remote - [on/off only]	RX40	\$312.00
Remote - [on/off + thermostatic control]	RX60	\$398.00
DelRay Square Fan Kit - [on/off, heat sensor fans, manual fan speed control]	DRFK2	\$383.00
DRSQ46 Invisimesh Screen	SCRIDRSQ46	\$438.00

Ω Mobile home compatible units can be ordered by adding an (MH) to the end of the unit order code



DIVINE SINGLE SIDED

# H34, HLB34, HLB34-2

LEGACY H SERIES

- Convertible to top or rear flue vent
- H34DF - traditional burner and logset, manual Hi-Lo flame control
- HLB34DFI - concealed burner with Ice fireglass, manual Hi-Lo flame control
- HLB34DFI-2 - concealed burner, speckled stones, driftwood, multi-function remote control, remote controlled fans, remote Hi-Lo flame control, black reflective glass

**MUST ORDER:**  Fireplace



HLB34 with reflective glass panels shown

## A Select the fireplace:

### H34DF\* OUT OF PRODUCTION - LIMITED QUANTITIES AVAILABLE

Part	Code		List price
18,000 BTU NG/LP Standard model with Hi/Lo Valve 4" / 7" venting	NG	H34DFN	\$2,393.00
	LP	H34DFL	
18,000 BTU Model equipped with Proflame 2 IPI† 4" / 7" venting	LP	H34DFLI	\$2,667.00
Shipping weight: 138lb Shipping length: 39½" Width: 21½" Height: 39½"			

### HLB34DF\*1 OUT OF PRODUCTION - LIMITED QUANTITIES AVAILABLE

Part	Code		List price
18,000 BTU Model equipped with Proflame 2 IPI Concealed Linear Burner 4" / 7" venting	NG	HLB34DFNI	\$3,084.00
Unit supplied with 2 bags of Ice fireglass. [HW1157] Shipping weight: 138lb Shipping length: 39½" Width: 21½" Height: 39½"			

### HLB34DF\*1-2 DELUXE OUT OF PRODUCTION - LIMITED QUANTITIES AVAILABLE

Part	Code		List price
18,000 BTU NG/LP Model equipped with Proflame 2 IPI Concealed Linear Burner, reflective glass panels, remote control, fan kit, 4" / 7" venting	NG	HLB34DFNI-2	\$4,711.00
	LP	HLB34DFLI-2	
Unit supplied with speckled stones and driftwood Shipping weight: 138lb Unit shipping length: 39½" Width: 21½" Height: 39½"			

## Optional venting components:

### COMPATIBLE VENTING

Unit	Reference
H34DF*, HLB34DF*1	4" / 7" Direct Vent Components - Page 35

### COMPATIBLE POWER VENTS

Part	Reference
4" / 7" Power Vent Systems	External Wall Mount Power Vent - Page 43 External Roof Mount Power Vent - Page 44 Flush Louvered Inline Power Vent - 200 - Page 45

## Optional components:

### DIVINE ACCESSORIES

Part	Code	List price
Surround - [satin black]	H34SFPSB	\$636.00
Surround - [stainless steel]	H34SFPSS	\$1,362.00
Colonial Brick Lining - [white] - H34 only	HBK34SHC	\$318.00
Heritage Brick Lining - [brown] - H34 only	HBK34SHR	\$370.00
Herring Bone Brick Lining - H34 only	HBK34H	\$390.00
Rustic Brick Lining - [brown] - H34 only	HBK34SRB	\$441.00
Rustic Brick Lining - [red] - H34 only	HBK34SRR	\$441.00
Reflective Glass Panel Kit - HLB34 only	RGPH34	\$473.00
Wrought Iron Grate - H34 only	HWIG34	\$57.00
Fan Kit - [on/off, heat sensor fans, manual fan speed control]	HFK50	\$530.00

### SIT IPI PROFLAME 2 SYSTEM ONLY

Wireless FULL LOAD Remote Control Kit - [on/off, thermostatic control, manual override, flame modulation, battery back-up] NOTICE - order RX100* when ECA062PV power vent is used	RX200NG	\$791.00
	RX200LP	\$791.00
Wall Mounted Proflame 2 Remote	REC1493	\$261.00
Emergency Battery Back-up	AF40BP	\$25.00
Fan Kit - [requires RX200*]	HFK50R	\$441.00

### STANDING PILOT ONLY

Remote Control Kit - [on/off only]	RX40	\$312.00
Remote Control Kit - [on/off + thermostatic control]	RX60	\$398.00
Remote Control Kit - [on/off, thermostatic control, wire harness, flame modulation]	RX82NG	\$692.00
	RX82LP	\$692.00
Remote Fan Control - [requires RX82*]	RFCB	\$375.00
Fan Kit - [2 pc fan kit, manual]	HFK42	\$421.00

## Optional decorative media:

### MEDIA OPTIONS

Part	Code	List price
HLB34 Speckled Stones	RR150SS	\$232.00
HLB34 Driftwood Logset	LGS59	\$271.00
H34 Designer River Rock Kit [NG only]	RBHR34R	\$478.00
HLB34 Glass Media [Requires 2 bags to complete installation]	Designer Burner Accessories - Page 51	

DIVINE SINGLE SIDED

# H38, HL38, HW38

LEGACY H SERIES

- Convertible to top or rear flue vent
- H38DF - traditional burner and logset, manual Hi-Lo flame control
- HL38DF - contemporary burner with Ice fireglass, manual Hi-Lo flame control
- HW38DF-2 - wildfire burner and logset, Herringbone brick liner, wrought iron grate, multi-function remote control, battery backup, remote Hi-Lo flame control

**MUST ORDER:**  Fireplace

## A Select the fireplace:

### H38DF\*\* OUT OF PRODUCTION - LIMITED QUANTITIES AVAILABLE

Part	Code		List price
26,000 BTU NG/LP Standard model with Hi/Lo Valve	NG	H38DFN	\$2,684.00
	LP	H38DFL	
26,000 BTU NG/LP Model equipped with Proflame 2 IPI†	NG	H38DFNI	\$2,957.00
Shipping weight: 167lb Shipping length: 42½" Width: 22" Height: 42½"			

### HL38DF\*\* OUT OF PRODUCTION - LIMITED QUANTITIES AVAILABLE

Part	Code		List price
25,000 BTU NG Standard linear burner model with Hi/Lo Valve	NG	HL38DFN	\$2,828.00
25,000 BTU NG linear burner model equipped with Proflame 2 IPI†	NG	HL38DFNI	\$3,274.00
Unit supplied with 2 bags of Ice fireglass. [HW1157] Shipping weight: 167lb Shipping length: 42½" Width: 22" Height: 42½"			

## Optional venting components:

### COMPATIBLE VENTING

Unit	Reference
H38DF*, HW38DF**, HL38DF*1	5" / 8" Direct Vent Components - Page 37

### COMPATIBLE POWER VENTS

Part	Reference
4"/7" Power Vent Systems	External Wall Mount Power Vent - Page 43 External Roof Mount Power Vent - Page 44 Flush Louvered Inline Power Vent - 200 - Page 45

† IPI Base Builders System does not include remote control.



H38 shown

## Optional components:

### DIVINE ACCESSORIES

Part	Code	List price
Surround - [satin black]	H38SFPSB	\$728.00
Surround - [stainless steel]	H38SFSS	\$1,453.00
Colonial Brick Lining - [white] - H38 only	HBK38C	\$334.00
Heritage Brick Lining - [brown] - H38 only	HBK38R	\$390.00
Herring Bone Brick Lining - H38 only	HBK38H	\$476.00
Porcelain Panel Kit - HW38 only	PPHW38	\$633.00
Reflective Glass Panel Kit - H38, HL38 only	RGPH38	\$522.00
Wrought Iron Grate - H38 only	HWIG38	\$83.00
Fan Kit - [on/off, heat sensor fans, manual fan speed control]	HFK50	\$530.00

### SIT IPI PROFLAME 2 SYSTEM ONLY

FULL LOAD Remote Control Kit - [on/off, thermostatic control, manual override, flame modulation, battery back-up] NOTICE - order RX100* when ECA062PV power vent is used	RX100NG	\$538.00
	RX100LP	\$538.00
Wall Mounted Proflame 2 Remote	REC1493	\$261.00
Emergency Battery Back-up	AF40BP	\$25.00
Remote Control Kit - [on/off, thermostatic control, manual override, battery back-up]	PF2RK	\$405.00
Fan Kit - [requires RX100* or PF2RK]	HFK50R	\$441.00

### STANDING PILOT ONLY

Remote Control Kit - [on/off only]	RX40	\$312.00
Remote Control Kit - [on/off + thermostatic control]	RX60	\$398.00
Remote Control Kit - [on/off, thermostatic control, wire harness, flame modulation]	RX82NG	\$692.00
	RX82LP	\$692.00
Remote Fan Control - [requires RX82*]	RFCB	\$375.00
Fan Kit - [2 pc fan kit, manual]	HFK42	\$421.00

## Optional decorative media:

### MEDIA OPTIONS

Part	Code	List price
H38 Designer River Rock Kit [NG only]	RBHR38R	\$488.00
HL38 Glass Media [Requires 2 bags to complete installation]	Designer Burner Accessories - Page 51	

# DIVINE SINGLE SIDED H42, HL42, HW42

LEGACY H SERIES

- Convertible to top or rear flue vent
- H42DF - traditional burner and logset, manual Hi-Lo flame control
- HL42DF - contemporary burner with Ice fireglass, manual Hi-Lo flame control
- HW42DF-2 - Wildfire burner and logset, Herringbone brick liner, wrought iron grate, multi-function remote control, battery backup, remote Hi-Lo flame control

**MUST ORDER:**  Fireplace



H42 shown

## A Select the fireplace:

### H42DF\* OUT OF PRODUCTION - LIMITED QUANTITIES AVAILABLE

Part	Code		List price
34,000 BTU NG / 32,000 BTU LP Model equipped with Proflame 2 IPI†	NG	H42DFNI	\$3,516.00
	LP	H42DFLI	
Shipping weight: 215lb Shipping length: 44" Width: 24" Height: 43"			

### HL42DF\*\* OUT OF PRODUCTION - LIMITED QUANTITIES AVAILABLE

Part	Code		List price
34,000 BTU NG / 32,000 BTU LP linear burner model model equipped with Proflame 2 IPI†	NG	HL42DFNI	\$3,932.00
Unit supplied with 2 bags of Ice fireglass. [HW1157] Shipping weight: 215lb Shipping length: 44" Width: 24" Height: 43"			

### HW42DF\*1-2 OUT OF PRODUCTION - LIMITED QUANTITIES AVAILABLE

Part	Code		List price
34,000 BTU NG Standard model equipped with Proflame 2 IPI Complete with remote control with on/off, thermostatic control, flame modulation, + battery backup. [fans not included]	NG	HW42DFNI-2	\$5,030.00
Shipping weight: 215lb Shipping length: 44" Width: 24" Height: 43"			

## Optional venting components:

### COMPATIBLE VENTING

Unit	Reference
H42, HL42, HW42	5"/8" Direct Vent Components - Page 37

### COMPATIBLE POWER VENTS

Part	Reference
4"/7" Power Vent Systems	External Wall Mount Power Vent - Page 43 External Roof Mount Power Vent - Page 44 Flush Louvered Inline Power Vent - 200 - Page 45

## Optional components:

### DIVINE ACCESSORIES

Part	Code	List price
Surround - [satin black]	H42SFP5B	\$818.00
Surround - [stainless steel]	H42SFP5S	\$1,543.00
Colonial Brick Lining - [white] - H42 only	HBK42C	\$354.00
Heritage Brick Lining - [brown] - H42 only	HBK42R	\$405.00
Herring Bone Brick Lining - H42 only	HBK42H	\$495.00
Reflective Glass Panel Kit	RGPH42	\$562.00
Wrought Iron Grate - H42 only	HWIG42	\$83.00
Fan Kit - [on/off, heat sensor fans, manual fan speed control]	HFK50	\$530.00

### SIT IPI PROFLAME 2 SYSTEM ONLY

FULL LOAD Remote Control Kit - [on/off, thermostatic control, manual override, flame modulation, battery back-up]	RX100NG	\$538.00
	RX100LP	\$538.00
Wall Mounted Proflame 2 Remote	REC1493	\$261.00
Emergency Battery Back-up	AF40BP	\$25.00
Wireless Remote Control Kit - [on/off, thermostatic control, manual override switch, emergency battery backup]	PF2RK	\$405.00
Fan Kit - [requires RX100* or PF2RK]	HFK50R	\$441.00

### STANDING PILOT ONLY

Remote Control Kit - [on/off only]	RX40	\$312.00
Remote Control Kit - [on/off + thermostatic control]	RX60	\$398.00
Wireless Remote Control Kit - [on/off, thermostatic control, wire harness, flame modulation]	RX82NG	\$692.00
	RX82LP	\$692.00
Remote Fan Control - [requires RX82*]	RFCB	\$375.00
Fan Kit - [2 pc fan kit, manual]	HFK42	\$421.00

## Optional decorative media:

### MEDIA OPTIONS

Part	Code	List price
HL42 Glass Media [Requires 2 bags to complete installation]	Designer Burner Accessories - Page 51	
H42 Designer River Rock Kit [NG only]	RBHR42R	\$592.00

DIVINE SINGLE SIDED

# H36PV

LEGACY H SERIES

- Clean face, flush to the floor design
- Frameless door with tempered glass
- Integrated control system with Proflame 1 electronic ignition
- Built in power vent control box
- Natural gas
- Flush floor burner and logset, Herringbone liner, Wrought iron grate, Manual Hi-Lo flame control

**MUST ORDER:** **A** Fireplace, **B** Power vent

## A Select the fireplace:

H36PVNI <small>OUT OF PRODUCTION - LIMITED QUANTITIES AVAILABLE</small>			
Part	Code		List price
55,000 BTU NG Model equipped with Proflame IPI	NG	H36PVNI	\$8,202.00
Shipping weight: 439lb Unit shipping length: 52" Width: 26" Height: 53"			

## B Select the power vent:

### COMPATIBLE VENTING

Unit	Reference
H36PV	5"/8" Direct Vent Components - Page 37

### COMPATIBLE POWER VENTS

Part	Reference
4"/7" Power Vent Systems	External Wall Mount Power Vent - Page 43 External Roof Mount Power Vent - Page 44 Flush Louvered Inline Power Vent - 200 - Page 45



H36PV shown

## Optional components:

### DIVINE ACCESSORIES

Part	Code	List price
Wireless Remote Control Kit - [on/off only]	RXM40VAC	\$330.00

Power Vent must be ordered separately, Does not require separate Powervent control box.

# Divine See Through

LEGACY H SERIES

- Black doors with tempered glass
- Convertible to top or side flue vent
- Features traditional burner and logset, Heritage brick liner, wrought iron grate, manual Hi-Lo flame control

**MUST ORDER:**  Fireplace



H38ST shown

## A Select the fireplace:

H38FSD**			
Part	Code		List price
34,000 BTU NG / 32,000 BTU LP Standard model with Hi/Lo Valve	NG	H38FSDN	\$4,554.00
	LP	H38FSDL	
34,000 BTU NG / 32,000 BTU LP Model equipped with Proflame 2 IPI†	NG	H38FSDNI	\$4,919.00
	LP	H38FSDLI	
Shipping weight: 282lb Unit shipping length: 41½" Width: 26½" Height: 44"			

H42FSD**			
Part	Code		List price
37,000 BTU NG/LP Standard model with Hi/Lo Valve	NG	H42FSDN	\$5,744.00
	LP	H42FSDL	
37,000 BTU NG/LP Model equipped with Proflame 2 IPI†	NG	H42FSDNI	\$6,002.00
	LP	H42FSDLI	
Shipping weight: 317lb Unit shipping length: 47" Width: 29½" Height: 48½"			

## Optional venting components:

### COMPATIBLE VENTING

Unit	Reference
H38ST, H42ST	5"/8" Direct Vent Components - Page 37

### COMPATIBLE POWER VENTS

Part	Reference
4"/7" Power Vent Systems	External Wall Mount Power Vent - Page 43 External Roof Mount Power Vent - Page 44 Flush Louvered Inline Power Vent - 200 - Page 45

## Optional media (with linear conversion):

### MEDIA OPTIONS

Part	Reference
Linear Burner Conversion Kit - Supplied with Ice fireglass. [HW1157]. 3 bags for the H38ST, 4 bags for the H42ST	Designer Burner Accessories - Page 51

## Optional components:

### DIVINE ACCESSORIES

Part	Code	List price
H38ST Surround - [satin black]	H38SFPSB	\$728.00
H38ST Surround - [stainless]	H38SFSS	\$1,453.00
H42ST Surround - [satin black]	H42SFPSB	\$818.00
H42ST Surround - [stainless]	H42SFSS	\$1,543.00
Fan Kit - [on/off, heat sensor fans, manual fan speed control]	HFK50	\$530.00
H38ST Linear Burner Conversion Kit, IPI NG - [Traditional to Linear]	RBHL38S17R	\$2,076.00
H38ST Linear Burner Conversion Kit, IPI LP - [Traditional to Linear]	RBHL38S18R	\$2,076.00
H42ST Linear Burner Conversion Kit, IPI NG - [Traditional to Linear]	RBHL42S17R	\$2,234.00
H42ST Linear Burner Conversion Kit, IPI LP - [Traditional to Linear]	RBHL42S18R	\$2,234.00

### SIT IPI PROFLAME 2 SYSTEM ONLY

FULL LOAD Remote Control Kit - [on/off, thermostatic control, manual override, flame modulation, battery back-up]	RX100NG	\$538.00
	RX100LP	\$538.00
Wall Mounted Proflame 2 Remote	REC1493	\$261.00
Remote Control Kit - [on/off, thermostatic control, manual override switch, battery back-up]	PF2RK	\$405.00
Emergency Battery Back-up	AF40BP	\$25.00
Fan Kit - [requires RX100* or PF2RK]	HFK50R	\$441.00

### STANDING PILOT ONLY

Remote Control Kit - [on/off only]	RX40	\$312.00
Remote Control Kit - [on/off + thermostatic control]	RX60	\$398.00
Remote Control Kit - [on/off, thermostatic control, wire harness, flame modulation]	RX82NG	\$692.00
	RX82LP	\$692.00
Remote Fan Control - [requires RX82*]	RFCB	\$375.00
Fan Kit - [2 pc fan kit, manual]	HFK42	\$421.00

† IPI Base Builders System does not include remote control.

DIVINE MULTI SIDED  
**Divine Pier**

LEGACY H SERIES

- Black doors with tempered glass
- Convertible to top or rear flue vent
- HL38PF\*I-2 - Contemporary burner with Ice fireglass, remote Hi-Lo flame control, multi-function remote control, battery backup
- H38PF\*I-2 - Traditional burner and logset, Heritage brick liner, wrought iron grate, remote Hi-Lo flame control, multi-function remote control, battery backup

**MUST ORDER:**  Fireplace



H38PFNI-2 shown

**A** Select the fireplace:

**H38PF\*I-2 TRADITIONAL**

Part	Code		List price
34,000 BTU NG / 32,000 BTU LP Model with Proflame 2 IPI Complete with remote control with on/off, thermostatic control, flame modulation, + battery backup. No fan options available.	NG	H38PFNI-2	\$6,285.00
	LP	H38PFLI-2	
Shipping weight: 340lb Unit shipping length: 46" Width: 27" Height: 48"			

**HL38PF\*I-2 CONTEMPORARY**

Part	Code		List price
34,000 BTU NG / 32,000 BTU LP linear burner model with Proflame 2 IPI Complete with remote control with on/off, thermostatic control, flame modulation, + battery backup. No fan options available.	NG	HL38PFNI-2	\$6,285.00
	LP	HL38PFLI-2	
Unit supplied with 5 bags of Ice fireglass. [HW1157] Shipping weight: 340lb Unit shipping length: 46" Width: 27" Height: 48"			

**Optional venting components:**

**COMPATIBLE VENTING**

Unit	Reference
H38PFC, HL38PFC	5"/8" Direct Vent Components - Page 37

**COMPATIBLE POWER VENTS**

Part	Reference
4"/7" Power Vent Systems	External Wall Mount Power Vent - Page 43 External Roof Mount Power Vent - Page 44 Flush Louvered Inline Power Vent - 200 - Page 45

**Optional decorative media:**

**LINEAR DIVINE PFC MEDIA OPTIONS**

Part	Code	List price
Firestones [Requires 5 bags to complete installation]	HW****	\$63.00
Fireglass [Requires 5 bags to complete installation]	HW****	\$53.00
Ice Fireglass [Requires 5 bags to complete installation]	HW1157	\$31.00
Firebeads [Requires 5 bags to complete installation]	HW****	\$22.00
Refer to Page 51. for media options and part numbers		

**Optional components:**

**DIVINE ACCESSORIES**

Part	Code	List price
Wall Mounted Proflame 2 Remote	REC1493	\$261.00



DIVINE MULTI SIDED  
**Divine Bay**

LEGACY H SERIES

- Black doors with tempered glass
- Convertible to top or rear flue vent
- HL38PR\*1-2 - Contemporary burner with Ice fireglass, remote Hi-Lo flame control, multi-function remote control, battery backup
- H38PR\*1-2 - Traditional burner and logset, Heritage brick liner, wrought iron grate, remote Hi-Lo flame control, multi-function remote control, battery backup

**MUST ORDER:**  Fireplace



HL38PRC shown

**A Select the fireplace:**

**H38PR\*1-2 TRADITIONAL**

Part	Code		List price
34,000 BTU NG / 32,000 BTU LP Model equipped with Proflame 2 IPI Complete with remote control with on/off, thermostatic control, flame modulation, + battery backup. No fan options available.	NG	H38PRNI-2	\$6,285.00
	LP	H38PRLI-2	
Shipping weight: 363lb Unit shipping length: 47" Width: 29" Height: 48"			

**HL38PR\*1-2 CONTEMPORARY**

Part	Code		List price
34,000 BTU NG / 32,000 BTU LP linear burner model with Proflame 2 IPI Complete with remote control with on/off, thermostatic control, flame modulation, + battery backup. No fan options available.	NG	HL38PRNI-2	\$6,285.00
	LP	HL38PRLI-2	
Unit supplied with 5 bags of Ice fireglass. [HW1157] Shipping weight: 363lb Unit shipping length: 47" Width: 29" Height: 48"			

**Optional venting components:**

**COMPATIBLE VENTING**

Unit	Reference
H38PRC, HL38PRC	5"/8" Direct Vent Components - Page 37

**COMPATIBLE POWER VENTS**

Part	Reference
4"/7" Power Vent Systems	External Wall Mount Power Vent - Page 43 External Roof Mount Power Vent - Page 44 Flush Louvered Inline Power Vent - 200 - Page 45

**Optional decorative media:**

**LINEAR DIVINE PRC MEDIA OPTIONS**

Part	Code	List price
Firestones [Requires 5 bags to complete installation]	HW****	\$63.00
Fireglass [Requires 5 bags to complete installation]	HW****	\$53.00
Ice Fireglass [Requires 5 bags to complete installation]	HW1157	\$31.00
Firebeads [Requires 5 bags to complete installation]	HW****	\$22.00
Refer to Page 51. for media options and part numbers		

**Optional components:**

**DIVINE ACCESSORIES**

Part	Code	List price
Wall Mounted Proflame 2 Remote	REC1493	\$261.00

# DIVINE MULTI SIDED Divine Corner

LEGACY H SERIES

- Black doors with tempered glass
- Convertible to top or rear flue vent
- HL38C\*\*I-2 - Contemporary burner with Ice fireglass, remote Hi-Lo flame control, multi-function remote control, battery backup
- H38C\*\*I-2 - Traditional burner and logset, Heritage brick liner, wrought iron grate, remote Hi-Lo flame control, multi-function remote control, battery backup

**MUST ORDER:**  Fireplace



H38CL shown

## A Select the fireplace:

### H38CL\*I-2 TRADITIONAL CORNER LEFT

Part	Code		List price
34,000 BTU NG / 32,000 BTU LP Model with Proflame 2 IPI†	NG	H38CLNI-2	\$6,285.00
	LP	H38CLLI-2	
Shipping weight: 356lb Unit shipping length: 47" Width: 29" Height: 48"			

### HL38CL\*I-2 CONTEMPORARY CORNER LEFT

Part	Code		List price
34,000 BTU NG / 32,000 BTU LP linear burner model with Proflame 2 IPI†	NG	HL38CLNI-2	\$6,285.00
	LP	HL38CLLI-2	
Unit supplied with 5 bags of Ice fireglass. [HW1157] Shipping weight: 356lb Unit shipping length: 47" Width: 29" Height: 48"			

### H38CR\*I-2 TRADITIONAL CORNER RIGHT

Part	Code		List price
34,000 BTU NG / 32,000 BTU LP Model with Proflame 2 IPI†	NG	H38CRNI-2	\$6,285.00
	LP	H38CRLI-2	
Shipping weight: 356lb Unit shipping length: 47" Width: 29" Height: 48"			

### HL38CR\*I-2 CONTEMPORARY CORNER RIGHT

Part	Code		List price
34,000 BTU NG / 32,000 BTU LP linear burner model with Proflame 2 IPI†	NG	HL38CRNI-2	\$6,285.00
	LP	HL38CRLI-2	
Unit supplied with 5 bags of Ice fireglass. [HW1157] Shipping weight: 356lb Unit shipping length: 47" Width: 29" Height: 48"			

## Optional venting components:

### COMPATIBLE VENTING

Unit	Reference
H38CL/CR, HL38CL/CR	5"/8" Direct Vent Components - Page 37

### COMPATIBLE POWER VENTS

Part	Reference
4"/7" Power Vent Systems	External Wall Mount Power Vent - Page 43 External Roof Mount Power Vent - Page 44 Flush Louvered Inline Power Vent - 200 - Page 45

## Optional decorative media:

### LINEAR DIVINE CORNER MEDIA OPTIONS

Part	Code	List price
Firestones [Requires 5 bags to complete installation]	HW****	\$63.00
Fireglass [Requires 5 bags to complete installation]	HW****	\$53.00
Ice Fireglass [Requires 5 bags to complete installation]	HW1157	\$31.00
Firebeads [Requires 5 bags to complete installation]	HW****	\$22.00
Refer to Page 51. for media options and part numbers		

## Optional components:

### DIVINE ACCESSORIES

Part	Code	List price
Wall Mounted Proflame 2 Remote	REC1493	\$261.00

† IPI System is complete with remote control with on/off, thermostatic control, flame modulation, + battery backup. No fan options available.

PHENOM

# L38FSD, L42FSD, L52FSD

LEGACY L SERIES

- Contemporary burner with Ice fireglass
- Comes with Proflame 2 BASIC control system
- Manual Hi-Lo flame control

**MUST ORDER:**  Fireplace



L42FSD shown

## A Select the fireplace:

L38FSD**			
Part	Code		List price
27,000 BTU NG/LP Standard model with linear burner and Hi/Lo Valve	NG	L38FSDN	\$5,616.00
	LP	L38FSDL	
27,000 BTU NG/LP Model with linear burner Proflame 2 IPI†	NG	L38FSDNI	\$5,951.00
	LP	L38FSDLI	

Unit supplied with 4 bags for standard, 5 for IPI of Ice fireglass. [HW1157].  
Shipping weight: 259lb Shipping length: 46" Width: 27½" Height: 42½"

L42FSD**			
Part	Code		List price
34,000 BTU NG/LP Standard model with linear burner and Hi/Lo Valve	NG	L42FSDN	\$6,749.00
	LP	L42FSDL	
34,000 BTU NG/LP Model with linear burner Proflame 2 IPI†	NG	L42FSDNI	\$7,039.00
	LP	L42FSDLI	

Unit supplied with 4 bags for standard, 6 for IPI of Ice fireglass. [HW1157].  
Shipping weight: 275lb Shipping length: 46" Width: 27½" Height: 42½"

L52FSD**			
Part	Code		List price
40,000 BTU NG/LP Standard model with linear burner and Hi/Lo Valve	NG	L52FSDN	\$9,544.00
	LP	L52FSDL	
40,000 BTU NG/LP Model with linear burner Proflame 2 IPI†	NG	L52FSDNI	\$9,877.00
	LP	L52FSDLI	

Unit supplied with 4 bags for standard, 6 for IPI of Ice fireglass. [HW1157].  
Shipping weight: 295lb Shipping length: 63½" Width: 30" Height: 40"

## Optional venting components:

### COMPATIBLE VENTING

Unit	Reference
L38FSD, L42FSD, L52FSD	5"/8" Direct Vent Components - Page 37

### COMPATIBLE POWER VENTS

Part	Reference
4"/7" Power Vent Systems	External Wall Mount Power Vent - Page 43 External Roof Mount Power Vent - Page 44 Flush Louvered Inline Power Vent - 200 - Page 45

## Optional decorative media:

### PHENOM MEDIA OPTIONS

Part	Code	List price
Firestones [See unit description for quantity needed.]	HW****	\$63.00
Fireglass [See unit description for quantity needed.]	HW****	\$53.00
Ice Fireglass [See unit description for quantity needed.]	HW1157	\$31.00
Firebeads [See unit description for quantity needed.]	HW****	\$22.00

Refer to Page 51. for media options and part numbers

## Optional components:

### PHENOM ACCESSORIES

L38FSD Surround - [satin black] ‡	P38SFPSPB	\$728.00
L38FSD Surround - [stainless] ‡	P38SFPSS	\$1,453.00
L42FSD Surround - [satin black] ‡	P42SFPSPB	\$818.00
L42FSD Surround - [stainless] ‡	P42SFPSS	\$1,543.00
L52FSD Surround - [satin black] ‡	P52SFPSPB	\$911.00
L52FSD Surround - [stainless] ‡	P52SFPSS	\$1,637.00
L38FSD and L42FSD Fan Kit - [on/off, heat sensor fans, manual fan speed control]	HFK50	\$530.00

### SIT IPI PROFLAME 2 SYSTEM ONLY

FULL LOAD Remote Control Kit - [on/off, thermostatic control, manual override switch, flame modulation, battery back-up]	RX100NG	\$538.00
	RX100LP	\$538.00
Wall Mounted Proflame 2 Remote	REC1493	\$261.00
Remote Control Kit - [on/off, thermostatic control, manual override, battery back-up]	PF2RK	\$405.00
Emergency Battery Back-up	AF40BP	\$25.00
L38FSD and L42FSD Fan Kit - [requires RX100* or PF2RK]	HFK50R	\$441.00

### STANDING PILOT ONLY

Remote Control Kit - [on/off only]	RX40	\$312.00
Remote Control Kit - [on/off + thermostatic control]	RX60	\$398.00
Remote Control Kit - [on/off, thermostatic control, wire harness, flame modulation]	RX82NG	\$692.00
	RX82LP	\$692.00
Remote Fan Control- [requires RX82*]	RFCB	\$375.00
L38FSD and L42FSD Fan Kit- [2 pc fan kit, manual. Requires RFCB]	HFK42	\$421.00

‡QTY 2 is required to finish both sides of the fireplace  
† IPI Base Builders System does not include remote control.

MONTIGO

PHENOM

# P38, P42, P52

LEGACY P SERIES

- Snap-lock door for access to the firebox
- Concealed burner with Quartz firebeads, Multi-function remote control, remote controlled fans, black porcelain liner, halogen uplighting, remote Hi-Lo flame control, battery backup

**MUST ORDER:**  Fireplace



P52 with optional speckled stones and driftwood

## A Select the fireplace:

P38DF*1-2			
Part	Code		List price
25,000 BTU NG/LP Model equipped with Proflame 2 IPI 5"/8" venting	NG	P38DFNI-2	\$5,859.00
	LP†	P38DFLI-2	
Unit supplied with 3 bags of Quartz firestones [HW1106] Shipping weight: 197lb Unit shipping length: 41½" Width: 21½" Height: 33"			

P42DF*1-2			
Part	Code		List price
32,000 BTU NG/LP Model equipped with Proflame 2 IPI 5"/8" venting	NG	P42DFNI-2	\$6,527.00
	LP†	P42DFLI-2	
Unit supplied with 4 bags of Quartz firestones [HW1106] Shipping weight: 228lb Unit shipping length: 45" Width: 24" Height: 37½"			

P52DF*1-2			
Part	Code		List price
40,000 BTU NG/LP Model equipped with Proflame 2 IPI 5"/10" venting	NG	P52DFNI-2	\$7,365.00
	LP†	P52DFLI-2	
Unit supplied with 4 bags of Quartz firestones [HW1106] Shipping weight: 312lb Unit shipping length: 55½" Width: 26" Height: 39"			

## Optional decorative media:

### PHENOM MEDIA OPTIONS

Part	Code	List price
P38 Speckled Stones	RR250SS	\$422.00
P42 Speckled Stones	RR300SS	\$496.00
P52 Speckled Stones	RR350SS	\$580.00
Driftwood Logset	LGSPseries	\$536.00
Firestones [P38DF*1-2 requires 3 bags. P42DF*1-2, P52DF*1-2 requires 4 bags.]	HW****	\$63.00
Fireglass [P38DF*1-2 requires 3 bags. P42DF*1-2, P52DF*1-2 requires 4 bags.]	HW****	\$53.00
Ice Fireglass [P38DF*1-2 requires 3 bags. P42DF*1-2, P52DF*1-2 requires 4 bags.]	HW1157	\$31.00
Firebeads [P38DF*1-2 requires 3 bags. P42DF*1-2, P52DF*1-2 requires 4 bags.]	HW****	\$22.00
Refer to Page 51. for media options and part numbers		

## Optional venting components:

### COMPATIBLE VENTING

Unit	Reference
P38, P42	5"/8" Direct Vent Components - Page 37
P52	5"/10" Direct Vent Components - Page 39

### COMPATIBLE POWER VENTS

Part	Reference
4"/7" Power Vent Systems	External Wall Mount Power Vent - Page 43 External Roof Mount Power Vent - Page 44 Flush Louvered Inline Power Vent - 200 - Page 45

## Optional components:

### PHENOM ACCESSORIES

Part	Code	List price
P38 Decorative Surround - [satin black]	P38SFPSB	\$728.00
P38 Decorative Surround - [stainless]	P38SFSS	\$1,453.00
P42 Decorative Surround - [satin black]	P42SFPSB	\$818.00
P42 Decorative Surround - [stainless]	P42SFSS	\$1,543.00
P52 Decorative Surround - [satin black]	P52SFPSB	\$911.00
P52 Decorative Surround - [stainless]	P52SFSS	\$1,637.00
Wall Mounted Proflame 2 Remote	REC1493	\$261.00

PHENOM

PL38, PL42, PL52

LEGACY P SERIES

- Snap-lock door for access to the firebox
- Concealed burner with Ice fireglass.  
Comes with Proflame 2 BASIC control system

**MUST ORDER:**  Fireplace

**A Select the fireplace:**

PL38DF*1			
Part	Code		List price
25,000 BTU NG/LP Model with Proflame 2 Basic IPI† 5”/8” venting	NG	PL38DFNI	\$4,143.00
	LP	PL38DFLI	
Unit supplied with 3 bags of Ice fireglass. [HW1157] Shipping weight: 197lb Unit shipping length: 41½” Width: 21½” Height: 33”			

PL42DF*1			
Part	Code		List price
32,000 BTU NG/LP Model with Proflame 2 Basic IPI† 5”/8” venting	NG	PL42DFNI	\$4,782.00
	LP	PL42DFLI	
Unit supplied with 3 bags of Ice fireglass. [HW1157] Shipping weight: 228lb Unit shipping length: 45” Width: 24” Height: 37½”			

PL52DF*1			
Part	Code		List price
40,000 BTU NG/LP Model with Proflame 2 Basic IPI† 5”/10” venting	NG	PL52DFNI	\$5,579.00
	LP	PL52DFLI	
Unit supplied with 3 bags of Ice fireglass. [HW1157] Shipping weight: 312lb Unit shipping length: 55½” Width: 26” Height: 39”			

**Optional venting components:**

**COMPATIBLE VENTING**

Unit	Reference
PL38, PL42	5”/8” Direct Vent Components - Page 37
PL52	5”/10” Direct Vent Components - Page 39

**COMPATIBLE POWER VENTS**

Part	Reference
4”/7” Power Vent Systems	External Wall Mount Power Vent - Page 43 External Roof Mount Power Vent - Page 44 Flush Louvered Inline Power Vent - 200 - Page 45
<b>Must upgrade to Proflame 2 system to operate power vents</b>	

† Comes with Proflame 2 BASIC control module



PL52 with optional speckled stones and driftwood

**Optional decorative media:**

**PHENOM PL SERIES MEDIA OPTIONS**

Part	Code	List price
PL38 Speckled Stones	RR250SS	\$422.00
PL42 Speckled Stones	RR300SS	\$496.00
PL52 Speckled Stones	RR350SS	\$580.00
Driftwood Logset	LGSPseries	\$536.00
Firestones [PL38DF*1-2 requires 3 bags. PL42DF*1-2, PL52DF*1-2 requires 4 bags.]	HW****	\$63.00
Fireglass [PL38DF*1-2 requires 3 bags. PL42DF*1-2, PL52DF*1-2 requires 4 bags.]	HW****	\$53.00
Ice Fireglass [PL38DF*1-2 requires 3 bags. PL42DF*1-2, PL52DF*1-2 requires 4 bags.]	HW1157	\$31.00
Firebeads [PL38DF*1-2 requires 3 bags. PL42DF*1-2, PL52DF*1-2 requires 4 bags.]	HW****	\$22.00

Refer to Page 51. for media options and part numbers

**Optional components:**

**PHENOM PL SERIES ACCESSORIES**

Part	Code	List price
PL38 Surround - [satin black]	P38SFPSB	\$728.00
PL38 Surround - [stainless]	P38SFSS	\$1,453.00
PL38 Porcelain Panel Kit	PPL38	\$632.00
PL42 Surround - [satin black]	P42SFPSB	\$818.00
PL42 Surround - [stainless]	P42SFSS	\$1,543.00
PL42 Porcelain Panel Kit	PPL42	\$673.00
PL52 Surround - [satin black]	P52SFPSB	\$911.00
PL52 Surround - [stainless]	P52SFSS	\$1,637.00
PL52 Porcelain Panel Kit	PPL52	\$799.00
Fan Kit - [on/off, heat sensor fans, manual fan speed control]	HFK50	\$530.00
<b>SIT IPI PROFLAME 2 SYSTEM ONLY</b>		
Wireless FULL LOAD Remote Control Kit - [on/off, thermostatic control, manual override switch, flame modulation, emergency battery back-up] NOTE - order RX100* when ECA062PV Power Vent is used	RX200NG	\$791.00
	RX200LP	\$791.00
Wall Mounted Proflame 2 Remote	REC1493	\$261.00
Fan Kit - [requires RX200*]	HFK50R	\$441.00
Emergency Battery Back-up	AF40BP	\$25.00

MONTIGO





OUTDOOR SERIES

# Mahana

- Ventless design
- High quality 304 stainless steel construction
- Patented design by Montigo, #8,567,387
- No masonry structure required, listed for wood frame construction
- Concealed burner with Quartz firebeads, built in fan system, safety screen

**MUST ORDER:**  Fireplace

## A Select the fireplace:

PL42VO*E			
Part	Code		List price
28,000 BTU NG/LP Model equipped with Honeywell HSI No Hi/Lo adjustment available	NG	PL42VONE	\$6,278.00
	LP	PL42VOLE	
Unit supplied with 2 bags of Quartz firestones. [HW1106] Shipping weight: 140lb Unit shipping length: 46" Width: 14½" Height: 32½"			

PL60VO*E			
Part	Code		List price
47,000 BTU NG/LP Model equipped with Honeywell HSI No Hi/Lo adjustment available	NG	PL60VONE	\$10,630.00
	LP	PL60VOLE	
Unit supplied with 3 bags of Quartz firestones. [HW1106] Shipping weight: 288lb Unit shipping length: 69" Width: 18" Height: 38"			

## Optional decorative media:

### MAHANA MEDIA OPTIONS

Part	Code	List price
PL42VO Speckled Stones	RR150SS	\$232.00
PL60VO Speckled Stones	RR300SS	\$496.00
PL42VO Driftwood Logset	LGS59	\$271.00
PL60VO Driftwood Logset (Requires x2)	LGS59	\$271.00
Firestones [PL42VO*E requires 2 bags. PL60VO*E requires 3 bags.]	HW****	\$63.00
Fireglass [PL42VO*E requires 2 bags. PL60VO*E requires 3 bags.]	HW****	\$53.00
Ice Fireglass [PL42VO*E requires 2 bags. PL60VO*E requires 3 bags.]	HW1157	\$31.00
Firebeads [PL42VO*E requires 2 bags. PL60VO*E requires 3 bags.]	HW****	\$22.00

Refer to Page 51. for media options and part numbers



PL42VO shown with optional cerulean color enclosure

## Optional components:

### MAHANA ACCESSORIES

Part	Code	List price
Fireplace Touchscreen Remote On/Off - [Includes weatherproof box]	RXM40VACVO	\$489.00
PL42VO Multi-color LED kit with remote	MCLED42VO	\$582.00
PL42VO Premium zippered enclosure cover	PL42CVR	\$151.00
PL42VO enclosure [Stainless Steel]	PL42VOBE	\$2,316.00
PL42VO enclosure pedestal [Stainless Steel]	PL42VOBE-P	\$330.00
PL42VO color enclosure [Carbon]	PL42VOCAR	\$2,443.00
PL42VO color enclosure [Graphite]	PL42VOGRA	\$2,443.00
PL42VO color enclosure [Dune]	PL42VODUN	\$2,443.00
PL42VO color enclosure [Sangria]	PL42VOSAN	\$2,443.00
PL42VO color enclosure [Citrus]	PL42VOCIT	\$2,443.00
PL42VO color enclosure [Sol]	PL42VOSOL	\$2,443.00
PL42VO color enclosure [Cerulean]	PL42VOCER	\$2,443.00
PL60VO Multi-color LED kit with remote	MCLED60VO	\$707.00
PL60VO Premium zippered enclosure cover	PL60CVR	\$184.00
PL60VO enclosure [Stainless Steel]	PL60VOBE	\$2,688.00
PL60VO enclosure pedestal [Stainless Steel]	PL60VOBE-P	\$531.00
PL60VO color enclosure [Carbon]	PL60VOCAR	\$2,816.00
PL60VO color enclosure [Graphite]	PL60VOGRA	\$2,816.00
PL60VO color enclosure [Dune]	PL60VODUN	\$2,816.00
PL60VO color enclosure [Sangria]	PL60VOSAN	\$2,816.00
PL60VO color enclosure [Citrus]	PL60VOCIT	\$2,816.00
PL60VO color enclosure [Sol]	PL60VOSOL	\$2,816.00
PL60VO color enclosure [Cerulean]	PL60VOCER	\$2,816.00

### AVAILABLE MAHANA ENCLOSURE COLORS:

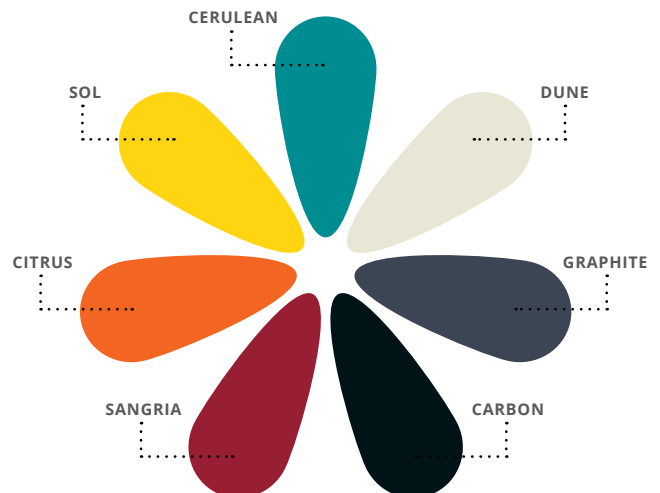

OUTDOOR SERIES

# Divine Ventless Outdoor

LEGACY H OUTDOOR

- Clean face design
- Stainless steel door with tempered glass
- Snap-lock door for access to the firebox
- Hi/lo control to adjust flame level (standing pilot only)
- Ventless design
- H\*VO - Traditional burner and logset
- HL38VO - Contemporary burner with Ice fireglass
- Includes screen

**MUST ORDER:**  Fireplace

## A Select the fireplace:

H34VO**			
Part	Code		List price
26,000 BTU NG/LP Standard model with Hi/Lo Valve	NG	H34VON	\$3,618.00
	LP	H34VOL	
26,000 BTU NG/LP Model equipped with Honeywell HSI No Hi/Lo adjustment available†	NG	H34VONE	\$3,873.00
	LP	H34VOLE	
Shipping weight: 149lb Unit shipping length: 39½" Width: 21½" Height: 39½"			

H38VO**			
Part	Code		List price
34,000 BTU NG/LP Standard model with Hi/Lo Valve	NG	H38VON	\$4,134.00
	LP	H38VOL	
34,000 BTU NG/LP Model equipped with Honeywell HSI No Hi/Lo adjustment available†	NG	H38VONE	\$4,390.00
	LP	H38VOLE	
Shipping weight: 169lb Unit shipping length: 42½" Width: 22" Height: 42½"			

HL38VO**			
Part	Code		List price
34,000 BTU NG/LP Standard model with Hi/Lo Valve	NG	HL38VON	\$4,134.00
	LP	HL38VOL	
34,000 BTU NG/LP Model equipped with Honeywell HSI No Hi/Lo adjustment available†	NG	HL38VONE	\$4,390.00
	LP	HL38VOLE	
Unit supplied with 3 bags of Ice fireglass. [HW1157] Shipping weight: 169lb Unit shipping length: 42½" Width: 22" Height: 42½"			

H42VO**			
Part	Code		List price
40,000 BTU NG/LP Standard model with Hi/Lo Valve	NG	H42VON	\$4,875.00
	LP	H42VOL	
40,000 BTU NG/LP Model equipped with Honeywell HSI No Hi/Lo adjustment available†	NG	H42VONE	\$5,135.00
	LP	H42VOLE	
Shipping weight: 188lb Unit shipping length: 46" Width: 25½" Height: 43"			

† HSI equipped; use ground fault protected outlet in fireplace.



H38VON shown with optional heritage brown brick liner

## Optional components:

### DIVINE ACCESSORIES

Part	Code	List price
H34VO Colonial Brick Lining - [white]	HBK34SHC	\$318.00
H34VO Heritage Brick Lining - [brown]	HBK34SHR	\$370.00
H34VO Herring Bone Brick Lining	HBK34H	\$390.00
H34VO Mirror Back Panel	RPH34VOR	\$171.00
H38VO Colonial Brick Lining - [white]	HBK38C	\$334.00
H38VO Heritage Brick Lining - [brown]	HBK38R	\$390.00
H38VO Herring Bone Brick Lining	HBK38H	\$476.00
H38VO Mirror Back Panel	RPH38VOR	\$295.00
H42VO Colonial Brick Lining - [white]	HBK42C	\$354.00
H42VO Heritage Brick Lining - [brown]	HBK42R	\$405.00
H42VO Herring Bone Brick Lining	HBK42H	\$495.00
H42VO Mirror Back Panel	RPH42VOR	\$479.00
H34VO Wrought Iron Grate	HWIG34	\$57.00
H38VO Wrought Iron Grate	HWIG38	\$83.00
H42VO Wrought Iron Grate	HWIG42	\$83.00
H34VO Drain Pan	ODSSP34	\$228.00
H38VO, HL38VFO Drain Pan	ODSSP38	\$249.00
H42VO Drain Pan	ODSSP42	\$278.00

## Optional decorative media:

### LINEAR MEDIA OPTIONS

Part	Code	List price
Firestones [HL38VO** requires 3 bags to complete installation]	HW****	\$63.00
Fireglass [HL38VO** requires 3 bags to complete installation]	HW****	\$53.00
Ice Fireglass [HL38VO** requires 3 bags to complete installation]	HW1157	\$31.00
Firebeads [HL38VO** requires 3 bags to complete installation]	HW****	\$22.00

Refer to Page 51. for media options and part numbers



OUTDOOR SERIES

# Divine ST Ventless Outdoor

LEGACY H OUTDOOR

- H38SVO - Traditional burner and logset, manual Hi-Lo flame control, wrought iron grate, safety screen
- HL38SVO - Contemporary burner with Ice fireglass, Manual Hi-Lo flame control, safety screen
- Clean face design
- Stainless steel doors with tempered glass
- Snap-lock door for access to the firebox
- Ventless design

**MUST ORDER:**  Fireplace

## A Select the fireplace:

H38SVO**			
Part	Code		List price
45,000 BTU NG/LP Standard model with Hi/Lo Valve	NG	H38SVON	\$8,093.00
	LP	H38SVOL	
45,000 BTU NG/LP Model with Honeywell HSI No Hi/Lo adjustment ††	NG	H38SVONE	\$8,353.00
	LP	H38SVOLE	
Shipping weight: 209lb Unit shipping length: 46" Width: 27½" Height: 42½"			

HL38SVO**			
Part	Code		List price
45,000 BTU NG/LP Standard model with Hi/Lo Valve	NG	HL38SVON	\$8,093.00
	LP	HL38SVOL	
45,000 BTU NG/LP Model with Honeywell HSI No Hi/Lo adjustment ††	NG	HL38SVONE	\$8,353.00
	LP	HL38SVOLE	
Unit supplied with 4 bags of Ice fireglass. [HW1157] Shipping weight: 209lb Unit shipping length: 46" Width: 27½" Height: 42½"			



HL38SVO shown without screens

## Optional components:

### DIVINE ACCESSORIES

Part	Code	List price
Freestanding cool to the touch stainless steel enclosure - field installed (HSI units only)	H38SVOBE	\$2,372.00

## Optional decorative media:

### LINEAR MEDIA OPTIONS

Part	Code	List price
Firestones [HL38SVO** requires 4 bags to complete installation]	HW****	\$63.00
Fireglass [HL38SVO** requires 4 bags to complete installation]	HW****	\$53.00
Ice Fireglass [HL38SVO** requires 4 bags to complete installation]	HW1157	\$31.00
Firebeads [HL38SVO** requires 4 bags to complete installation]	HW****	\$22.00

Refer to Page 51. for media options and part numbers

† HSI equipped; use ground fault protected outlet in fireplace.



# ILLUME 30FID

## LEGACY INSERTS

- Decorative surround
- 30FID\*\*S - Ceramic burner and logset, Multi-function remote control, Halogen downlighting, Remote Hi-Lo flame control, Battery backup, Invisimesh screen
- 30FID\*\*L - Contemporary burner, Multi-function remote control, Black porcelain liner, Halogen uplighting, Remote Hi-Lo flame control, Battery backup, Invisimesh screen

**MUST ORDER:** **A** Fireplace, **B** venting, **C** surround, **D** liner\*\*, **E** media\*\*

## **A** Select the fireplace:

### 30FIDNIS-01 TRADITIONAL

Part	Code	List price
24,000 BTU NG / 23,000 BTU LP Model equipped with Proflame 2 IPI 3"x3" Co-linear Direct Vent	NG 30FIDNIS-01	\$3,508.00
	LP GCA003	\$142.00

### MUST ORDER BELOW LOGSET TO COMPLETE INSTALLATION

High Def. Logset REQUIRED Ships separate from fireplace	LGS30FI	\$722.00
---	---------	----------

Shipping weight: 118lb Unit shipping length: 36" Width: 17" Height: 22"

### 30FIDNIL-01 CONTEMPORARY

Part	Code	List price
24,000 BTU NG / 23,000 BTU LP Model equipped with Proflame 2 IPI 3"x3" Co-linear Direct Vent	NG 30FIDNIL-01	\$4,142.00
	LP GCA003	\$142.00

Unit requires 3 bags of glass media, order separately.  
Shipping weight: 110lb Unit shipping length: 36" Width: 17" Height: 22"

## **B** Select the required venting components:

### 30FID VENTING COMPONENTS

Part	Code	List price
DuraVent Termination - High Wind	46DVA-VCH	\$171.00
DuraVent Co-linear to Co-axil Adaptor 3"x3"	46DVA-GK	\$356.00
DuraVent 3" Flex Linear Coupling [optional]	3DFA-FC	\$21.00
35' Length of 3" aluminum flex, bulk, compressed	VT35FL3BC	\$236.00

## **C** Select the required surround:

### 30FID SURROUND

Part	Code	List price
Square surround [satin black] [42" wide x 27" high]	FP30FID-01	\$390.00
Square surround offset kit - must order FP30FID [satin black] [43½" wide x 27½" high x 4¼" deep]	FP30FIDOF	\$254.00
Oversized Square surround [satin black] [48" wide x 30" high]	FP30FIDOS-01	\$422.00
4-sided surround [satin black] [42" wide x 32" high]	FP30FID4S-01	\$422.00

‡ Contemporary units do not require a liner order, they come standard with porcelain panels.



30FIDNIL-01 Linear with speckled stones and driftwood with square surround shown

## **D** (Traditional) Select the firebox liner:

### 30FID FIREBOX LINERS

Part	Code	List price
Ceramic Brick Lining - [brown] (Trad. only)	BRK30FIB	\$254.00
Ceramic Brick Lining - [red] (Trad. only)	BRK30FIR	\$254.00
Porcelain Panels - [black] (Standard in linear)	RPP30FID	\$589.00

Liner only required in traditional units (Contemporary units come standard with porcelain panels)

## **E** (Contemporary) Select the decorative media:

### 30FID CONTEMPORARY DECORATIVE MEDIA

Part	Code	List price
Driftwood Logset - [Must add speckled stones, firestones, or fireglass to complete installation]	LGS59	\$271.00
Speckled Stones	RR150SS	\$232.00
Firestones [Requires 3 bags to complete installation]	HW****	\$63.00
Fireglass [Requires 3 bags to complete installation]	HW****	\$53.00
Ice Fireglass [Requires 3 bags to complete installation]	HW1157	\$31.00
Firebeads [Requires 3 bags to complete installation]	HW****	\$22.00

Decorative media only required in contemporary units  
Refer to Page 51. for part numbers

## Optional components:

### 30FID COMPONENTS

Part	Code	List price
2-Fan Kit	RFKFIDECO	\$337.00

# ILLUME 34FID

## LEGACY INSERTS

- Decorative surround
- 30FID\*\*S - Ceramic burner and logset, Multi-function remote control, Halogen downlighting, Remote Hi-Lo flame control, Battery backup, Invisimesh screen
- 30FID\*\*L - Contemporary burner, Multi-function remote control, Black porcelain liner, Halogen uplighting, Remote Hi-Lo flame control, Battery backup, Invisimesh screen

**MUST ORDER:** **A** Fireplace, **B** venting, **C** surround, **D** liner\*\*, **E** media\*\*



34FIDNIL-01 Traditional with oversized surround shown

### **A** Select the fireplace:

#### 34FIDNIS-01 TRADITIONAL

Part	Code	List price
31,000 BTU NG / 30,000 BTU LP Model equipped with Proflame 2 IPI 3"x4" Co-linear Direct Vent	NG 34FIDNIS-01	\$3,930.00
	LP GCA006	\$142.00

#### MUST ORDER BELOW LOGSET TO COMPLETE INSTALLATION

High Def. Logset REQUIRED Ships separate from fireplace	LGS34FI	\$800.00
Shipping weight: 126lb Unit shipping length: 40" Width: 18" Height: 25"		

#### 34FIDNIL-01 CONTEMPORARY

Part	Code	List price
31,000 BTU NG / 30,000 BTU LP Model equipped with Proflame 2 IPI 3"x4" Co-linear Direct Vent	NG 34FIDNIL-01	\$4,645.00
	LP GCA006	\$142.00

Unit requires 3 bags of glass media, order separately.  
Shipping weight: 118lb Unit shipping length: 40" Width: 18" Height: 25"

### **B** Select the required venting components:

#### 34FID VENTING COMPONENTS

Part	Code	List price
Duravent Termination - High Wind	46DVA-VCH	\$171.00
Duravent Co-linear to Co-axil Adaptor 3"x4"	46DVA-CT	\$356.00
Duravent 3" Flex Linear Coupling [optional]	3DFA-FC	\$21.00
Duravent 4" Flex Linear Coupling [optional]	4DFA-FC	\$21.00
35' Length of 3" aluminum flex, bulk, compressed	VT35FL3BC	\$236.00
35' Length of 4" aluminum flex, bulk, compressed	VT35FL4BC	\$297.00

### **C** Select the required surround:

#### 34FID SURROUND

Part	Code	List price
Square surround [satin black] [46½" wide x 31" high]	FP34FID-01	\$439.00
Oversized Square surround [satin black] [52" wide x 33½" high]	FP34FIDOS-01	\$472.00
4-sided surround [satin black] [46½" wide x 36" high]	FP34FID4S-01	\$472.00

‡ Contemporary units do not require a liner order, they come standard with porcelain panels.

### **D** (Traditional) Select the firebox liner:

#### 34FID FIREBOX LINERS

Part	Code	List price
Ceramic Brick Lining - [brown] (Trad. only)	BRK34FIB	\$280.00
Ceramic Brick Lining - [red] (Trad. only)	BRK34FIR	\$280.00
Porcelain Panels - [black] (Standard in liner)	RPP34FID	\$650.00

Liner only required in traditional units (Contemporary units come standard with porcelain panels) Refer to Page 51. for media options and part numbers

### **E** (Contemporary) Select the decorative media:

#### 34FID CONTEMPORARY DECORATIVE MEDIA

Part	Code	List price
Driftwood Logset - [Must add speckled stones, firestones, or fireglass to complete installation]	LGS59	\$271.00
Speckled Stones	RR200SS	\$337.00
Firestones [Requires 3 bags to complete installation]	HW****	\$63.00
Fireglass [Requires 3 bags to complete installation]	HW****	\$53.00
Ice Fireglass [Requires 3 bags to complete installation]	HW1157	\$31.00
Firebeads [Requires 3 bags to complete installation]	HW****	\$22.00

Decorative media only required in contemporary units  
Refer to Page 51. for part numbers

### Optional components:

#### 34FID COMPONENTS

Part	Code	List price
2-Fan Kit	RFKFIDECO	\$337.00

# Exemplar Single Sided

LEGACY R SERIES

- Frameless design allows for brick or tile installation over the fireplace
- R320/420 convertible 5”/8” top or rear power vent
- R520/720/820 convertible 5”/10” top or rear power vent
- Contemporary burner with Ice fireglass, tempered glass, power vent control box
- 100% fail-safe shut-off valve

**MUST ORDER:** Fireplace, Power vent



R420 Shown

## A Select the fireplace:

R320*			
Part	Code		List price
50,000 BTU NG / 40,000 BTU LP Model with Honeywell HSI 5”/8” venting	NG	R320N	\$8,128.00
	LP	R320L	
Unit supplied with 3 bags of Ice fireglass. [HW1157] Unit shipping weight: 501lb - Unit length: 61” Width: 36” Height: 54”			
R420*			
Part	Code		List price
65,000 BTU NG / 55,000 BTU LP Model with Honeywell HSI 5”/8” venting	NG	R420N	\$10,566.00
	LP	R420L	
Unit supplied with 4 bags of Ice fireglass. [HW1157] Unit shipping weight: 602lb - Unit length: 77” Width: 36” Height: 54”			
R520*			
Part	Code		List price
80,000 BTU NG / 65,000 BTU LP Model with Honeywell HSI 5”/10” venting	NG	R520N	\$11,535.00
	LP	R520L	
Unit supplied with 5 bags of Ice fireglass. [HW1157] Unit shipping weight: 715lb - Unit length: 87” Width: 36” Height: 54”			
R720*			
Part	Code		List price
100,000 BTU NG / 80,000 BTU LP Model with Honeywell HSI 5”/10” venting	NG	R720N	\$13,483.00
	LP	R720L	
Unit supplied with 9 bags of Ice fireglass. [HW1157] Unit shipping weight: 845lb - Unit length: 111” Width: 36” Height: 54”			
R820*			
Part	Code		List price
100,000 BTU NG / 80,000 BTU LP Model with Honeywell HSI 5”/10” venting	NG	R820N	\$15,151.00
	LP	R820L	
Unit supplied with 10 bags of Ice fireglass. [HW1157] Unit shipping weight: 927lb - Unit length: 123” Width: 36” Height: 54”			

## B Select the required power vent:

### COMPATIBLE POWER VENTS

Part	Reference
5”/8” Power Vent Systems	Wall Mount Power Vent - 300 - Page 46 Roof Mount Power Vent - 300 - Page 47 Flush Louvered Power Vent - 300 - Page 48
5”/10” Power Vent Systems	Wall Mount Power Vent - 300 - Page 46 Roof Mount Power Vent - 300 - Page 47 Flush Louvered Power Vent - 300 - Page 48

## Optional decorative media:

### EXEMPLAR MEDIA OPTIONS

Part	Code	List price
R320 Driftwood Logset	LGS58 (x1)	\$330.00
R420 Driftwood Logset R520 Driftwood Logset	LGS57 (x1)	\$280.00
	LGS58 (x2)	\$330.00
R720 Driftwood Logset R820 Driftwood Logset	LGS57 (x1)	\$280.00
	LGS58 (x3)	\$330.00
R320 Speckled Stones	RR450SS	\$748.00
R420 Speckled Stones	RR500SS	\$800.00
R520 Speckled Stones	RR500SS	\$800.00
R720 Speckled Stones	RR600SS (x1)	\$989.00
	RR200SS (x1)	\$337.00
R820 Speckled Stones	RR600SS (x1)	\$989.00
	RR300SS (x1)	\$496.00
Firestones [R320* requires 3 bags, R420* requires 4 bags, R520* requires 5 bags, R720* requires 9 bags, R820* requires 10 bags]	HW****	\$63.00
Fireglass [R320* requires 3 bags, R420* requires 4 bags, R520* requires 5 bags, R720* requires 9 bags, R820* requires 10 bags]	HW****	\$53.00
Ice Fireglass [R320* requires 3 bags, R420* requires 4 bags, R520* requires 5 bags, R720* requires 9 bags, R820* requires 10 bags]	HW1157	\$31.00
Firebeads [R320* requires 3 bags, R420* requires 4 bags, R520* requires 5 bags, R720* requires 9 bags, R820* requires 10 bags]	HW****	\$22.00
Refer to Page 51. for media options and part numbers		

## Optional components:

### EXEMPLAR ACCESSORIES

Part	Code	List price
Wireless Remote Kit [on/off only]	RXM40VAC	\$330.00

Gas type not convertible.  
Power Vent must be ordered separately

# Exemplar See Through

LEGACY R SERIES

- Frameless design allows for brick or tile installation over the fireplace
- R320/420ST 5"/8" power vent
- R520/620ST 5"/10" power vent
- Contemporary burner with Ice fireglass, tempered glass, power vent control box
- 100% fail-safe shut-off valve

**MUST ORDER:** Fireplace, Power vent

## A Select the fireplace:

R320ST*			
Part	Code		List price
45,000 BTU NG / 42,000 BTU LP Model with Honeywell HSI 5"/8" venting	NG	R320STN	\$10,566.00
	LP	R320STL	
Unit supplied with 5 bags of Ice fireglass. [HW1157] Unit shipping weight: 601lb - Unit length: 61" Width: 36" Height: 54"			
R420ST*			
Part	Code		List price
55,000 BTU NG/LP Model with Honeywell HSI 5"/8" venting	NG	R420STN	\$12,508.00
	LP	R420STL	
Unit supplied with 7 bags of Ice fireglass. [HW1157] Unit shipping weight: 625lb - Unit length: 77" Width: 36" Height: 54"			
R520ST*			
Part	Code		List price
80,000 BTU NG/LP Model with Honeywell HSI 5"/10" venting	NG	R520STN	\$13,621.00
	LP	R520STL	
Unit supplied with 8 bags of Ice fireglass. [HW1157] Unit shipping weight: 755lb - Unit length: 87" Width: 36" Height: 54"			
R620ST*			
Part	Code		List price
100,000 BTU NG/LP Model with Honeywell HSI 5"/10" venting	NG	R620STN	\$14,734.00
	LP	R620STL	
Unit supplied with 9 bags of Ice fireglass. [HW1157] Unit shipping weight: 941lb - Unit length: 97" Width: 36" Height: 54"			

## B Select the required power vent:

### COMPATIBLE POWER VENTS

Part	Reference
5"/8" Power Vent Systems	Wall Mount Power Vent - 300 - Page 46 Roof Mount Power Vent - 300 - Page 47 Flush Louvered Power Vent - 300 - Page 48
5"/10" Power Vent Systems	Wall Mount Power Vent - 300 - Page 46 Roof Mount Power Vent - 300 - Page 47 Flush Louvered Power Vent - 300 - Page 48

Gas type not convertible.  
Power Vent must be ordered separately



R320ST Shown

## Optional decorative media:

### EXEMPLAR MEDIA OPTIONS

Part	Code	List price
R320ST Driftwood Logset	LGS58 (x1)	\$330.00
R420ST Driftwood Logset R520ST Driftwood Logset	LGS57 (x1)	\$280.00
	LGS58 (x2)	\$330.00
R620ST Driftwood Logset	LGS57 (x1)	\$280.00
	LGS58 (x2)	\$330.00
	LGS59 (x1)	\$271.00
R720ST Driftwood Logset R820ST Driftwood Logset	LGS57 (x1)	\$280.00
	LGS58 (x3)	\$330.00
R320ST Speckled Stones	RR450SS	\$748.00
R420ST Speckled Stones	RR500SS	\$800.00
R520ST Speckled Stones	RR500SS	\$800.00
R620ST Speckled Stones	RR600SS	\$989.00
R720ST Speckled Stones	RR600SS (x1)	\$989.00
	RR200SS (x1)	\$337.00
R820ST Speckled Stones	RR600SS (x1)	\$989.00
	RR300SS (x1)	\$496.00
Firestones [R320ST* requires 3 bags, R420ST* requires 4 bags, R520ST* requires 5 bags, R720ST* requires 9 bags, R820ST* requires 10 bags]	HW****	\$63.00
Fireglass [R320ST* requires 3 bags, R420ST* requires 4 bags, R520ST* requires 5 bags, R720ST* requires 9 bags, R820ST* requires 10 bags]	HW****	\$53.00
Ice Fireglass [R320ST* requires 3 bags, R420ST* requires 4 bags, R520ST* requires 5 bags, R720ST* requires 9 bags, R820ST* requires 10 bags]	HW1157	\$31.00
Firebeads [R320ST* requires 3 bags, R420ST* requires 4 bags, R520ST* requires 5 bags, R720ST* requires 9 bags, R820ST* requires 10 bags]	HW****	\$22.00

Refer to Page 51. for media options and part numbers

## Optional components:

### EXEMPLAR ACCESSORIES

Part	Code	List price
Wireless Remote Kit [on/off only]	RXM40VAC	\$330.00
R320ST Indoor/Outdoor Sealing Kit	IOSK3	\$2,514.00
R420ST Indoor/Outdoor Sealing Kit	IOSK4	\$2,682.00
R520ST Indoor/Outdoor Sealing Kit	IOSK5	\$2,850.00
R620ST Indoor/Outdoor Sealing Kit	IOSK6	\$3,185.00

EXEMPLAR

# Exemplar RP620

LEGACY R SERIES

- Frameless window design
- Power vent dedicated
- Convertible to top or rear flue vent
- Integrated barrier safety screen
- Compatible with 24VAC home automation systems
- Concealed burner with Quartz firebeads, black porcelain liner, halogen uplighting

**MUST ORDER:** **A** Fireplace, **B** Power vent

## A Select the fireplace:

RP620*			
Part	Code		List price
75,000 BTU NG / 70,000 BTU LP Model equipped with Honeywell HSI No Hi-Lo adjustment available	NG	RP620N	\$19,513.00
	LP	RP620L	
Unit supplied with 8 bags of Quartz firestones. [HW1106] Unit shipping weight: 943lb - Unit length: 98" Width: 36" Height: 54"			

## B Select the required power vent:

### COMPATIBLE VENTING

Unit	Reference
RP620	5"/8" Direct Vent Components - Page 37

### COMPATIBLE POWER VENTS

Part	Reference
5"/8" Power Vent Systems	Wall Mount Power Vent - 300 - Page 46 Roof Mount Power Vent - 300 - Page 47 Flush Louvered Power Vent - 300 - Page 48



RP620 with optional speckled stones and driftwood shown

## Optional decorative media:

### RP620 MEDIA OPTIONS

Part	Code	List price
Firestones [Requires 8 bags to complete installation]	HW****	\$63.00
Fireglass [Requires 8 bags to complete installation]	HW****	\$53.00
Ice Fireglass [Requires 8 bags to complete installation]	HW1157	\$31.00
Firebeads [Requires 8 bags to complete installation]	HW****	\$22.00
Designer Speckled Stones	RR600SS	\$989.00
Driftwood Logset - Natural Gas	LGRP6N	\$1,060.00
Driftwood Logset - Liquid Propane	LGRP6L	\$832.00
Refer to Page 51. for media options and part numbers		

## Optional components:

### RP620 ACCESSORIES

Part	Code	List price
Wireless Remote Control Kit - [on/off only]	RXM40VAC	\$330.00

Gas type not convertible.  
Power Vent must be ordered separately

EXEMPLAR

# Exemplar Indoor Outdoor

LEGACY R SERIES

- 50,000 BTU NG/LP
- Indoor-outdoor dedicated
- Concealed burner with Ice fireglass
- Frameless firebox design for inside glass
- Sealing frame for outside glass
- Built in downdraft Power Vent system that requires no venting
- HSI ignition
- Invisimesh screen

**MUST ORDER:**  Fireplace

## **A** Select the fireplace:

### R324STIO\*

Part	Code		List price
50,000 BTU NG/LP Model equipped with Honeywell HSI No Hi-Lo adjustment available	NG	R324STION	\$10,702.00
	LP	R324STIOL	
Unit supplied with 7 bags of Ice fireglass. [HW1157] Unit shipping weight: 605lb - Unit length: 62" Width: 36" Height: 57"			



R324STIO Shown

## Optional decorative media:

### R324STIO OPTIONS

Part	Code	List price
Firestones [Requires 7 bags to complete installation]	HW****	\$63.00
Fireglass [Requires 7 bags to complete installation]	HW****	\$53.00
Ice Fireglass [Requires 7 bags to complete installation]	HW1157	\$31.00
Firebeads [Requires 7 bags to complete installation]	HW****	\$22.00
Designer Speckled Stones	RR450SS	\$748.00
Driftwood Logset [must order 2 to complete install]	LGS58	\$330.00
Refer to Page 51. for media options and part numbers		

## Optional components:

### R324STIO ACCESSORIES

Part	Code	List price
Porcelain Panel Kit	PPR324	\$632.00

Gas type not convertible.



# Exemplar Pier

LEGACY R SERIES

- Glass barrier that meets safety standards  
- No mesh screens required
- Frameless window design
- Zero clearance to combustibles, including facing
- Concealed burner, halogen uplighting, reflective firebox liner
- Your choice of speckled stones, firestones, or fireglass
- 5”/8” Venting

**MUST ORDER:** **A** Fireplace, **B** Power vent, **C** media

## A Select the fireplace:

RP424PF*			
Part	Code		List price
45,000 BTU NG/LP Model with Honeywell HSI No Hi-Lo adjustment available	NG	RP424PFN	\$20,158.00
	LP†	RP424PFL	
Unit shipping weight: 877lb - Unit length: 74” Width: 40½” Height: 66”			

## B Select the required power vent:

### COMPATIBLE VENTING

Unit	Reference
RP424	5”/8” Direct Vent Components - Page 37

### COMPATIBLE POWER VENTS

Part	Reference
5”/8” Power Vent Systems	Wall Mount Power Vent - 300 - Page 46 Roof Mount Power Vent - 300 - Page 47 Flush Louvered Power Vent - 300 - Page 48

## C Select decorative media:

### RP424 MEDIA OPTIONS

Part	Code	List price
Firestones [Requires 7 bags to complete installation]	HW****	\$NC
Fireglass [Requires 7 bags to complete installation]	HW****	\$NC
Ice Fireglass [Requires 7 bags to complete installation]	HW1157	\$NC
Firebeads [Requires 7 bags to complete installation]	HW****	\$NC
Designer Speckled Stones	RR500SS	\$NC
Refer to Page 51. for media options and part numbers		



RP424 with speckled stones and optional driftwood shown

## Optional components:

### RP424 ACCESSORIES

Part	Code	List price
Wireless Remote Control Kit - [on/off only]	RXM40VAC	\$330.00

## Optional decorative media:

### RP424 MEDIA OPTIONS

Part	Code	List price
Driftwood Logset	LGSPSeries	\$536.00

Power Vent must be ordered separately



# 4"/7" Direct Vent Components

## VENT PIPES - STRAIGHT RIGID

Part	Code	List price
18" Rigid Section [female/female]	EXT18	\$56.00
12" Rigid Section [female/male]	MEXT1	\$136.00
24" Rigid Section [female/male]	MEXT2	\$161.00
36" Rigid Section [female/male]	MEXT3	\$180.00
48" Rigid Section [female/male]	MEXT4	\$200.00
72" Rigid Section [female/male]	MEXT6	\$223.00

## VENT PIPES - FLEX SECTIONS<sup>‡</sup>

Part	Code	List price
12" Flex Section [female/female connectors]	MFL1	\$155.00
18" Flex Section [female/female]	MFL18	\$161.00
24" Flex Section [female/female]	MFL2	\$171.00
36" Flex Section [female/female]	MFL3	\$216.00
48" Flex Section [female/female]	MFL4	\$231.00
72" Flex Section [female/female]	MFL6	\$348.00

## VERTICAL INSTALLATION ADAPTER

Part	Code	List price
10" Flue Adapter for straight, vertical installations [female/female]	MXT10	\$34.00

## VENT CONNECTOR

Part	Code	List price
4"/7" Vent Connector [male/male]	MVA	\$29.00

## VENT PIPES - ELBOWS

Part	Code	List price
45° Solid Elbow Section [female/male connectors]	EEL45	\$91.00
90° Elbow [female/female]	MEL90F/F	\$171.00
90° Elbow [male/male]	MEL90M/M	\$171.00
90° Elbow [female/male]	MEL90F/M	\$171.00
Clearance Reducing Sleeve	CRS30	\$47.00

## HORIZONTAL TERMINATIONS<sup>†</sup>

Part	Code	List price
Termination without mounting frame [use with MSR or MOSR]	MTO4	\$214.00
Termination with integral mounting frame	MTO4F	\$246.00
Termination with continuous formed perimeter nailing flange	MTO4F-2	\$321.00
Stainless steel termination without mounting frame [use with MSRSS or MOSRSS]	MTO4SS	\$457.00
Stainless steel termination with integral mounting frame	MTO4FSS	\$467.00
Stainless steel termination with continuous formed perimeter nailing flange	MTO4F-2SS	\$497.00

## VERTICAL TERMINATION<sup>†</sup>

Part	Code	List price
Stainless steel termination for vertical installations, Includes MXT10 adapter [for straight, vertical installations]	MVTK1SS	\$280.00

## TERMINATION FRAMES<sup>†</sup>

Part	Code	List price
Siding or Stucco Frame [for easy installation of termination]	MSR	\$59.00
Siding or Stucco Can [for installing termination from the inside of building]	MOSR	\$112.00
Stainless Steel Siding or Stucco Frame [for easy installation of termination]	MSRSS	\$86.00
Stainless Steel Siding or Stucco Can [for installing termination from the inside of building]	MOSRSS	\$356.00
Brick Siding Can [for installation of termination on brick wall] BSR4 for 4" BSR6 for 6"	BSR4 BSR6	\$60.00 \$60.00

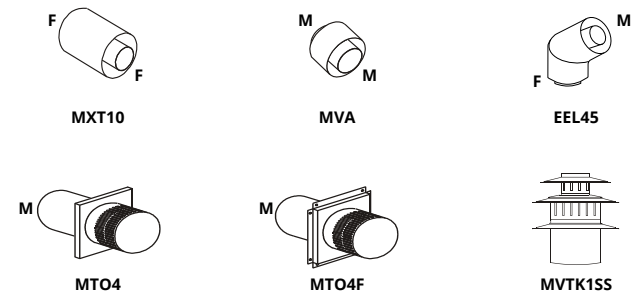
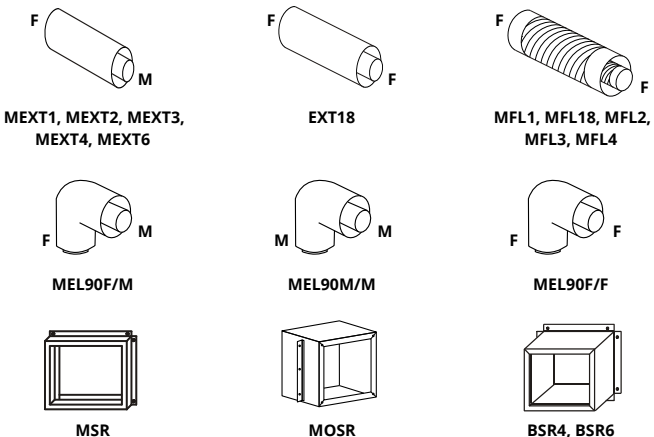

‡Please Note: You cannot cut our flex pipe

# 4"/7" Direct Vent Components Cont.

### SNORKEL TERMINATION

Part	Code	List price
18" Vertical Rise	SNK47-2	\$1,169.00
30" Vertical Rise	SNK47-3	\$1,282.00
2 week lead time for stainless steel terminations		

### HEAT GUARD

Part	Code	List price
Fits all 4/7" and 5"/8" terminations	MTKOG	\$177.00

### HEAT SHIELDS\*

Part	Code	List price
Through-the-wall Radiation Shield for 4"/7" venting	RHS100	\$115.00
Vinyl Siding Shield	VSS	\$34.00
Vinyl Siding Stainless Steel Shield	VSSSS	\$66.00

### VERTICAL INSTALLATION ACCESSORIES

Part	Code	List price
7" Firestop	FS7	\$19.00
7" Support Plate & Support Ring	MSPXT7	\$95.00
7" Support Plate & Support Ring [bulk pack of 6]	MSP706	\$355.00
Flashing and Storm Collar for 1/12 to 7/12 pitch roof	MRF7	\$76.00
Flashing and Storm Collar for 7/12 to 12/12 pitch roof	MRF12	\$102.00
Flat roof flashing and storm collar	FRF7	\$118.00

### HORIZONTAL VENT RESTRICTORS\*

Part	Code	List price
For 8' - 14' horizontal vent run	MHVR8	\$20.00
For 15' - 24" horizontal vent run	MHVR15	\$20.00
For 25' - 35' horizontal vent run	MHVR25	\$20.00

### VERTICAL VENT RESTRICTORS\*

Part	Code	List price
For 8' - 14' vertical vent run	MVVR8	\$20.00
For 15' - 24" vertical vent run	MVVR15	\$20.00
For 25' or greater vertical vent run	MVVR25	\$20.00

### THRU-THE-WALL VENTING KITS

Part	Code	List price
Wall Penetration Rigid Kit 18 Inch Kit includes RHS100 wall heat shield, MXT18 -18" F/F rigid pipe (can be cut up to 9" length) and MTO4 termination with frame. Suitable for corner installations and straight through the wall installations.	MRVK01	\$381.00
Wall Penetration Rigid Kit 18 Inch Kit includes RHS100 wall heat shield, MXT18 -18" F/F rigid pipe (can be cut up to 9" length) and MTO4F termination with frame. Suitable for straight through the wall installations.	MRVK01F	\$398.00
Wall Penetration Flex Kit 18 Inch Kit includes RHS100 wall heat shield, MFL18 flex pipe, and MTOF termination with frame. Suitable for corner installations and up and out installations.	MFVK01F	\$476.00
Wall Penetration Flex Kit for 2 x 4 Construction 18 Inch Kit Includes RHS100 wall heat shield, MFL18 flexible pipe, and MTO termination without frame. Suitable for corner installations and up and out installations.	MFVK01	\$454.00

### ADAPTERS

Part	Code	List price
DURAVENT 4 x 6-5/8 fireplace adapter	46DVA-AD-M1	\$72.00
DURAVENT 4 x 6-5/8 termination adapter	46DVA-AD-M2	\$72.00

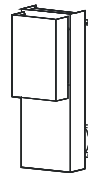

SNK47-2, SNK47-3

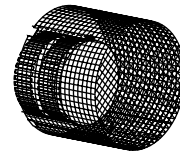

MTKOG



FS-7



MSPXT-7



MRF-7, MRF-12

\*Vent restrictors may not be required - contact your Montigo representative for more information

# 5" / 8" Direct Vent Components

### VENT PIPES - STRAIGHT RIGID

Part	Code	List price
5" Rigid Section [female/female]	PXT5	\$25.00
10" Rigid Section [female/female]	PXT10	\$37.00
12" Rigid Section [female/female]	PXT12	\$39.00
20" Rigid Section [female/female]	PXT20	\$90.00
12" Rigid Section [female/male connectors]	PEXT1	\$146.00
24" Rigid Section [female/male]	PEXT2	\$174.00
36" Rigid Section [female/male]	PEXT3	\$185.00
48" Rigid Section [female/male]	PEXT4	\$161.00
72" Rigid Section [female/male]	PEXT6	\$196.00

### VENT PIPES - FLEX SECTIONS†

Part	Code	List price
12" Flex Section [female/female connectors]	PFL1	\$171.00
18" Flex Section [female/female]	PFL18	\$179.00
24" Flex Section [female/female]	PFL2	\$187.00
36" Flex Section [female/female]	PFL3	\$231.00
48" Flex Section [female/female]	PFL4	\$259.00
72" Flex Section [female/female]	PFL6	\$391.00

### VENT PIPES - ELBOWS

Part	Code	List price
45° Elbow [female/male connectors]	PEL45F/M	\$110.00
90° Elbow [female/female]	PEL90F/F	\$189.00
90° Elbow [male/male]	PEL90M/M	\$189.00
90° Elbow [female/male]	PEL90F/M	\$183.00

### VERTICAL VENT REDUCER

Part	Code	List price
10" length, reduces 5" / 8" venting to 4" / 7" (male/female connectors)	PVA5487	\$121.00

### VENT CONNECTOR

Part	Code	List price
5" Vent Connector (male/male)	PVA	\$49.00

### HORIZONTAL TERMINATIONS†

Part	Code	List price
Termination without mounting frame [use with MSR or MOSR]	PTO4	\$246.00
Termination with integral mounting frame	PTO4F	\$280.00
Termination with continuous formed perimeter nailing flange	PTO4F-2	\$315.00
Stainless steel termination without mounting frame [use with MSRSS or MOSRSS]	PTO4SS	\$423.00
Stainless steel termination with integral mounting frame	PTO4FSS	\$456.00
Stainless steel termination with continuous formed perimeter nailing flange	PTO4F-2SS	\$524.00

### VERTICAL TERMINATION†

Part	Code	List price
Stainless steel termination for vertical installations, Includes PXT10 adapter [for straight, vertical installations]	PVTK1SS	\$297.00

### TERMINATION FRAMES†

Part	Code	List price
Siding or Stucco Frame [for easy installation of termination]	MSR	\$59.00
Siding or Stucco Can [for installing termination from the inside of building]	MOSR	\$112.00
Stainless Steel Siding or Stucco Frame [for easy installation of termination]	MSRSS	\$86.00
Stainless Steel Siding or Stucco Can [for installing termination from the inside of building]	MOSRSS	\$356.00
Brick Siding Can [for installation of termination on brick wall] BSR4 for 4" BSR6 for 6"	BSR4	\$60.00
	BSR6	\$60.00

F

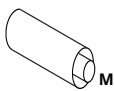

PEXT1, PEXT2, PEXT3, PEXT4, PEXT6

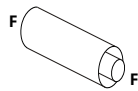

PXT5, PXT12, PXT20

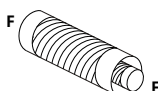

PFL1, PFL18, PFL2, PFL3, PFL4

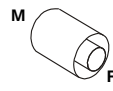

PVA5487



PVA

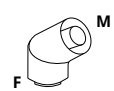

PEL45FM



PEL90F/M



PEL90M/M



PEL90F/F

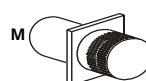

PTO4



PTO4F

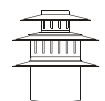

PVTK1SS

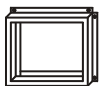

MSR

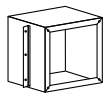

MOSR

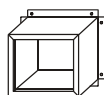

BSR4, BSR6

†Please Note: You cannot cut our flex pipe

# 5"/8" Direct Vent Components Cont.

### SNORKEL TERMINATION

Part	Code	List price
18" Vertical Rise	SNK58-2	\$1,260.00
30" Vertical Rise	SNK58-3	\$1,450.00

### HEAT GUARD

Part	Code	List price
Fits all 4/7" and 5"/8" terminations	MTKOG	\$177.00

### HEAT SHIELDS\*

Part	Code	List price
Through-the-wall Radiation Shield for 5"/8" venting	RHS101	\$119.00
Vinyl Siding Shield	VSS	\$34.00
Vinyl Siding Stainless Steel Shield	VSSSS	\$66.00

### VERTICAL INSTALLATION ACCESSORIES

Part	Code	List price
8" Firestop	FS8	\$20.00
8" Support Plate & Support Ring	PSPXT8	\$63.00
8" Support Plate & Support Ring [bulk pack of 6]	PSP806	\$347.00
Flashing and Storm Collar for 1/12 to 7/12 pitch roof	PRF7	\$71.00
Flashing and Storm Collar for 7/12 to 12/12 pitch roof	PRF12	\$149.00
Flat roof Flashing and Storm Collar	FRF8	\$131.00

### HORIZONTAL VENT RESTRICTORS\*

Part	Code	List price
For 8' - 14' horizontal vent run	PHVR8	\$20.00
For 15' - 24" horizontal vent run	PHVR15	\$20.00
For 25' - 35' horizontal vent run	PHVR25	\$20.00

### VERTICAL VENT RESTRICTORS\*

Part	Code	List price
For 8' - 14' vertical vent run	PVVR8	\$20.00
For 15' - 24" vertical vent run	PVVR15	\$20.00
For 25' or greater vertical vent run	PVVR25	\$20.00

### THRU-THE-WALL VENTING KITS

Part	Code	List price
Wall Penetration Flex Kit 18 inch with Frame* Kit includes RHS101 wall heat shield, PFL18 18 to 24 inch flexible pipe, and PTO4F termination with frame. Suitable for corner installations and up-and-out installations.	PFVK01F	\$470.00
Wall Penetration Flex Kit 18 inch* Kit includes RHS101 wall heat shield, PFL18 18 to 24 inch flexible pipe, and PTO4 termination without frame. Suitable for corner installations and up-and-out installations.	PFVK01	\$488.00
Wall Penetration Flex Kit 48 inch* Kit includes RHS101 wall heat shield, PFL4 48 to 72 inch flexible pipe, and PTO4 termination without frame. Suitable for corner installations and up-and-out installations.	PFVK04	\$562.00
Wall Penetration Flex Kit 4 feet with Frame* Kit includes RHS101 wall heat shield, PFL4 48 to 72 inch flexible pipe, and PTO4F termination with frame. Suitable for corner installations and up-and-out installations.	PFVK04F	\$562.00
Wall Penetration Kit Rigid Kit 18 inch Kit includes RHS101 wall heat shield, PXT18 -18" F/F rigid pipe (can be cut up to 9" length) and PTO4 termination without frame. Suitable for corner installations and straight through-the-wall installations.	PRVK01	\$393.00
Wall Penetration Kit Rigid Kit 18 inch with Frame Kit includes RHS101 wall heat shield, PXT18 -18" F/F rigid pipe (can be cut up to 9" length) and PTO4F termination with frame. Suitable for straight through-the-wall installations.	PRVK01F	\$410.00

### ADAPTERS

Part	Code	List price
DURAVENT 5/8 fireplace adapter	58DVA-AD-M1	\$74.00
DURAVENT 5/8 termination adapter	58DVA-AD-M2	\$74.00

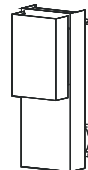

SNK58-2, SNK58-3

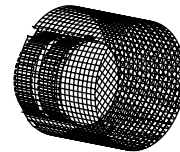

MTKOG

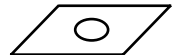

FS-8



PSPXT-8

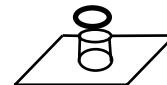

PRF-7, PRF-12

\*Vent restrictors may not be required - contact your Montigo representative for more information

# 5"/10" Direct Vent Components

## VENT PIPES - STRAIGHT RIGID

Part	Code	List price
10" Rigid Section [female/female]	RXT10	\$39.00
20" Rigid Section [female/female]	RXT20	\$73.00
12" Rigid Section [female/male connectors]	REXT1	\$134.00
24" Rigid Section [female/male]	REXT2	\$158.00
36" Rigid Section [female/male]	REXT3	\$186.00
48" Rigid Section [female/male]	REXT4	\$216.00
72" Rigid Section [female/male]	REXT6	\$262.00

## VENT PIPES - FLEX SECTIONS‡

Part	Code	List price
12" Flex Section [female/female connectors]	RFL1	\$236.00
24" Flex Section [female/female]	RFL2	\$262.00
36" Flex Section [female/female]	RFL3	\$324.00
48" Flex Section [female/female]	RFL4	\$361.00
72" Flex Section [female/female]	RFL6	\$545.00
Vent connector [male/male]	RVA	\$36.00

## VENT PIPES - ELBOWS

Part	Code	List price
45° Elbow [female/male connectors]	REL45F/M	\$167.00
90° Elbow [female/female]	REL90F/F	\$278.00
90° Elbow [male/male]	REL90M/M	\$278.00
90° Elbow [female/male]	REL90F/M	\$278.00

## VENT REDUCER

Part	Code	List price
10" - 8" Adapter Collar [for P52DF only]	RVA108	\$59.00
5"/10" to 4"/7" Adapter Collar Kit [for P52DF only]	LVA54107	\$214.00
5"/10" to 5"/8" Reducer [male/female connector]	RVA51058	\$214.00

## WALL PENETRATION KIT

Part	Code	List price
Kit includes RHS104 wall heat shield, RFL2 flexible pipe, and RTO4F termination with frame. Suitable for all TOP corner installations and up-and-out installations. [For P52DF only]	RFVK01F	\$632.00

## HEAT SHIELDS

Part	Code	List price
Through-the-wall Radiation Shield for 5"/10" Venting	RHS102	\$125.00
Through-the-wall Radiation Shield for 5"/10" Venting	RHS104	\$143.00

## HORIZONTAL TERMINATION

Part	Code	List price
Termination with integral mounting frame	RTO4F	\$320.00

## INSTALLATION ACCESSORIES

Part	Code	List price
10" Fire Stop	FS10	\$28.00
10" Support Plate and Ring	RSPXT10	\$67.00

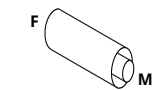

REXT1, REXT12, REXT13, REXT4, REXT6

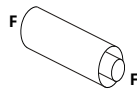

RXT10, RXT20

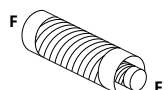

RFL1, RFL2, RFL3, RFL4



RVA

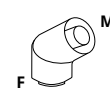

REL45FM

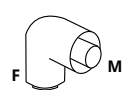

REL90F/M

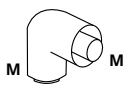

REL90M/M

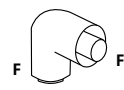

REL90F/F

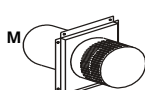

RTO4F



RSPXT-10



FS-10

‡Please Note: You cannot cut our flex pipe

# Heat Management

- Heat is diverted through the Cool Wall Advantage kit, safely bypassing the space above the fireplace.
- Reduced glass temperature, combined with the provided screen creates a safe viewing area.

**MUST ORDER:** **A** Cool wall system, **B** flex pipe

## A Select the Cool Wall system:

### CONVECTION COOL WALL SYSTEMS

Part	Code	List price
36" Cool Wall Advantage Kit [Includes louver, plenum, collars, requires HDKPDFK-1]	HDKPD36	\$544.00
48" Cool Wall Advantage Kit [Includes louver, plenum, collars, requires HDKPDFK]	HDKPD48	\$710.00
63" Cool Wall Advantage Kit [Includes louver, plenum, collars, requires HDKPDFK]	HDKPD63	\$993.00
72" Cool Wall Advantage Kit [Includes louver, plenum, collars, requires HDKPDFK]	HDKPD72	\$1,119.00
Cool Wall Advantage Side Discharge Kit Horizontal [Includes 2 louvers , 2 plenums, requires HDKPDFK]	HDKSD	\$417.00
Cool Wall Advantage Side Discharge Kit Vertical [Includes 2 louvers , 2 plenums, requires HDKPDFK]	HDKSVD	\$417.00

## B Select the flex pipe:

### COOL WALL SYSTEM FLEX

Part	Code	List price
Cool Wall Flex Kit [12' of 5" Diameter flex pipe, see chart below]	HDKPDFK-1	\$94.00
Cool Wall Flex Kit [24' of 5" Diameter flex pipe, see chart below]	HDKPDFK	\$194.00

## Optional venting louvers

### CAVITY VENTING LOUVERS

Part	Code	List price
36" Wall cavity venting louver	GR36	\$73.00
48" Wall cavity venting louver	GR48	\$99.00
63" Wall cavity venting louver	GR63	\$127.00
72" Wall cavity venting louver	GR72	\$143.00
Sidewall cavity venting louver horizontal [2 included]	GRSDH	\$122.00
Sidewall cavity venting louver vertical [2 included]	GRSDV	\$122.00

Cool Wall Advantage kit includes louvers, the above is the listing of the standalone venting louvers used to vent a wall cavity above a fireplace



Cool Wall Advantage Side Discharge Kit Vertical

### UNIT COMPATIBILITY

Cool wall system	D3615NI-2	D4815NI-2	D6315NI-2	D7215NI-2	DRL3613NI-*	DRL4813NI-*	DRSQ38NI-*	DRSQ42NI-*	DRSQ46NI-*
HDKPD36	✓				✓		✓		
HDKPD48		✓				✓		✓	✓
HDKPD63			✓						
HDKPD72				✓					
HDKSD	✓	✓	✓	✓	✓	✓	✓	✓	✓
HDKSVD	✓	✓	✓	✓	✓	✓	✓	✓	✓
HDKPDFK-1	✓				✓		✓		
HDKPDFK		✓	✓	✓		✓		✓	✓

Cool Wall Advantage Side Discharge Kit horizontal  
HDKSD  
[Includes 2 louvers , 2 plenums, requires flex kit]

Cool Wall Advantage Side Discharge Kit vertical  
HDKSVD  
[Includes 2 louvers , 2 plenums, requires flex kit]

Cool Wall Flex Kit  
HDKPDFK  
HDKPDFK-1  
[HDKPDFK-1 is 12' of 5" Diameter flex pipe, HDKPDFK is 24' of 5" Diameter flex pipe]

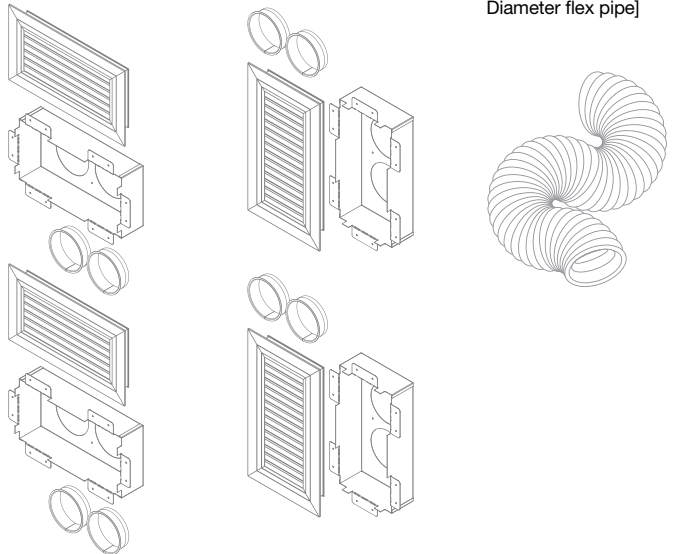

Cool Wall Advantage Kit  
HDKPD\*\*  
[Includes louver, plenum, requires flex kit]

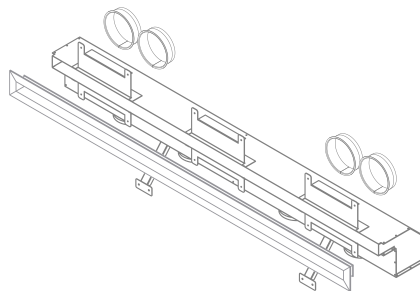



# Vent Kits

- 10' Wall kits, Roof kits, and Extension kits available soon
- Millpack/silicone is not included and must be field supplied

## 4/7 Horizontal vent kits

### 5' WALL PENETRATION KIT

Part	Code	List price
Wall Penetration Flex Kit Includes RHS100 wall heat shield, 5' flex pipe (with spacers), and MTO4 termination	MVK05	\$320.00
Wall Penetration Flex Kit (with term. frame) Includes RHS100 wall heat shield, 5' flex pipe (with spacers), and MTO4F	MVK05F	\$320.00

### 10' WALL PENETRATION KIT

Part	Code	List price
Wall Penetration Flex Kit Includes RHS100 wall heat shield, 10' flex pipe (with spacers), and MTO4 termination	MVK10	
Wall Penetration Flex Kit (with term. frame) Includes RHS100 wall heat shield, 10' flex pipe (with spacers), and MTO4F	MVK10F	

## 5/8 Horizontal vent kits

### 5' WALL PENETRATION KIT

Part	Code	List price
Wall Penetration Flex Kit Includes RHS101 wall heat shield, 5' flex pipe (with spacers), and PTO4 termination	PVK05	\$348.00
Wall Penetration Flex Kit (with term. frame) Includes RHS101 wall heat shield, 5' flex pipe (with spacers), and PTO4F	PVK05F	\$348.00

### 10' WALL PENETRATION KIT

Part	Code	List price
Wall Penetration Flex Kit Includes RHS101 wall heat shield, 10' flex pipe (with spacers), and PTO4 termination	PVK10	
Wall Penetration Flex Kit (with term. frame) Includes RHS101 wall heat shield, 10' flex pipe (with spacers), and PTO4F	PVK10F	

## 4/7 Vertical vent kits

### 20' ROOF PENETRATION KIT

Part	Code	List price
Roof Penetration Flex Kit Includes RHS100 wall heat shield, 20' flex pipe (with spacers), MEXT3 36" F/M rigid pipe, and MVTK1SS Roof Termination	MVK20V	

## 4/7 Vent extension kits

### 20' EXTENSION KIT

Part	Code	List price
Extension kit 20' flex pipe (with spacers), MVA connector	MVK20VE	

## 5/8 Vertical vent kits

### 20' ROOF PENETRATION KIT

Part	Code	List price
Roof Penetration Flex Kit Includes RHS101 wall heat shield, 20' flex pipe (with spacers), PEXT3 36" F/M rigid pipe, and PVTK1SS Roof Termination	PVK20V	

## 5/8 Vent extension kits

### 20' EXTENSION KIT

Part	Code	List price
Extension kit 20' flex pipe (with spacers), PVA connector	PVK20VE	



POWER VENTING

# External Wall Mount Power Vent

The external wall mount Power Vent System is a draft assisted system designed to accommodate extended horizontal exit direct vent installations. Where conventional direct vent systems are not possible, this venting system connects with Montigo's 4"/7" direct vent components, and is for use with a Montigo gas fireplace equipped with electronic ignition.

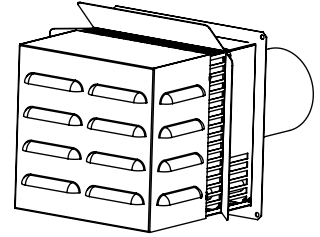

**MUST ORDER:** **A** Power vent, **B** Power cord, **C** Purge control, **D** Speed control

**Compatible with:** Divine, Phenom ST, Phenom, Distinction, DelRay equipped with Electronic Ignition

## **A** Order the power vent:

### WALL MOUNT TERMINATION

Part	Code	List price
Termination & Fan Motor 4"/7" (includes mounting frame)	PVHEX47-200	\$2,318.00

## **B** Order the power cord:

### EDPV POWER CORDS

Part	Code	List price
10 - Foot EDVPV Power Vent System power cord	EPVH-10	\$122.00
20 - Foot EDVPV Power Vent System power cord	EPVH-20	\$171.00
40 - Foot EDVPV Power Vent System power cord	EPVH-40	\$268.00
60 - Foot EDVPV Power Vent System power cord	EPVH-60	\$364.00
80 - Foot EDVPV Power Vent System power cord	EPVH-80	\$457.00
100 - Foot EDVPV Power Vent System power cord	EPVH-100	\$553.00

NOTE: FOR ARMORED POWERVENT CABLES PLEASE SEE MISCELLANEOUS COMPONENTS SECTION

## **C** Order the purge control box:

### POST PURGE CONTROL BOXES

Part	Code	List price
Phenom single sided Control Box	ECA045PC	\$673.00
Distinction Control Box	ECA111PV	\$759.00
DelRay Control Box	ECA136PV	\$759.00
Divine and Phenom ST (IPI only) Control Box	ECA062PV	\$673.00

Note: Ordering a control box not required for Exemplar or H36PV

## **D** Order the speed control box:

### FAN SPEED CONTROL BOXES

Part	Code	List price
Power Vent Fan speed Control Box	PVFCB	\$106.00

## Optional accessories:

### OPTIONAL ACCESSORIES

Part	Code	List price
Power Vent Adjustable Flue Restrictor [for 4"/7" vent system]	MVAFR02	\$59.00

### VENT REDUCER

Part	Code	List price
5"/8" venting to 4"/7" reducer	PVA5487	\$121.00
5"/8" venting to 4"/7" reducing collar [DelRay Square top vent only]	DRSQCOL47	\$160.00
5"/10" venting to 4"/7" reducing collar [Phenom P/PL52 only]	LVA54107	\$214.00

### COMPATIBLE VENTING

Venting
4"/7" Direct Vent Components - Page 35
5"/8" Direct Vent Components - Page 37

# External Roof Mount Power Vent

The external roof mount power vent is a draft assisted system designed to accommodate extended vertical exit direct vent installations. Where conventional direct vent systems are not possible or where power vents are required, this venting system connects with Montigo's 4"/7" direct vent components, and is for use with a Montigo gas fireplace equipped with electronic ignition.

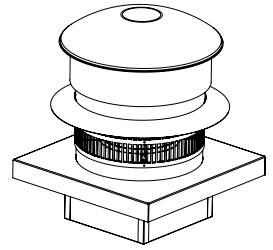

**MUST ORDER:** **A** Power vent, **B** Power cord, **C** Purge control, **D** Speed control

**Compatible with:** Divine, Phenom ST, Phenom, Distinction, DelRay equipped with Electronic Ignition

## **A** Order the power vent:

### ROOF MOUNT TERMINATION

Part	Code	List price
Termination & Fan Motor 4"/7" (Includes mounting frame)	PVEX47-200	\$3,070.00

## **B** Order the power cord:

### EDPV POWER CORDS

Part	Code	List price
10 - Foot EDVPV Power Vent System power cord	EPVH-10	\$122.00
20 - Foot EDVPV Power Vent System power cord	EPVH-20	\$171.00
40 - Foot EDVPV Power Vent System power cord	EPVH-40	\$268.00
60 - Foot EDVPV Power Vent System power cord	EPVH-60	\$364.00
80 - Foot EDVPV Power Vent System power cord	EPVH-80	\$457.00
100 - Foot EDVPV Power Vent System power cord	EPVH-100	\$553.00

NOTE: FOR ARMORED POWERVENT CABLES PLEASE SEE MISCELLANEOUS COMPONENTS SECTION

## **C** Order the purge control box:

### POST PURGE CONTROL BOXES

Part	Code	List price
Phenom single sided Control Box	ECA045PC	\$673.00
Distinction Control Box	ECA111PV	\$759.00
DelRay Control Box	ECA136PV	\$759.00
Divine and Phenom ST (IPI only) Control Box	ECA062PV	\$673.00
Note: Ordering a control box not required for Exemplar or H36PV		

## **D** Order the speed control box:

### FAN SPEED CONTROL BOXES

Part	Code	List price
Power Vent Fan speed Control Box	PVFCB	\$106.00

## Optional accessories:

### OPTIONAL ACCESSORIES

Part	Code	List price
Power Vent Adjustable Flue Restrictor [for 4"/7" vent system]	MVAFR02	\$59.00

### VENT REDUCER

Part	Code	List price
5"/8" venting to 4"/7" reducer	PVA5487	\$121.00
5"/8" venting to 4"/7" reducing collar [DelRay Square top vent only]	DRSQCOL47	\$160.00
5"/10" venting to 4"/7" reducing collar [Phenom P/PL52 only]	LVA54107	\$214.00

### COMPATIBLE VENTING

Venting
4"/7" Direct Vent Components - Page 35
5"/8" Direct Vent Components - Page 37

# Flush Louvered Inline Power Vent - 200

When external vents are not permitted, the PVHIN47-200 and TMHIN47 make the install of residential fireplaces possible. The flush termination allows for installation into combustible materials, concrete or curtain wall materials with ease. The termination is stainless steel for a long corrosion free life. This termination comes complete with the exterior louvers, which can be installed separately once the building construction is completed. The power head contains a brushless motor design and incorporates a built-in dilution system to allow vent speed reduction for smaller appliances without jeopardizing the motor's operational temperatures.

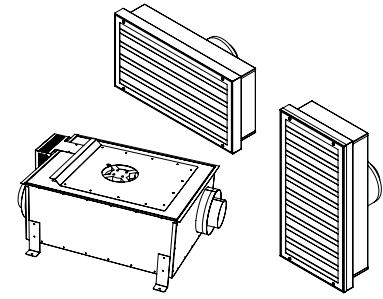

**MUST ORDER:** **A** Power vent, **B** Power cord, **C** Purge control, **D** Speed control, **E** Termination

**Compatible with:** Divine, Phenom ST, Phenom, Distinction, DelRay equipped with Electronic Ignition

## A Order the power vent:

### INLINE POWER VENT

Part	Code	List price
4"/7" Inline Power Vent	PVHIN47-200	\$2,317.00

## B Order the power cord:

### EDPV POWER CORDS

Part	Code	List price
10 - Foot EDVPV Power Vent System power cord	EPVH-10	\$122.00
20 - Foot EDVPV Power Vent System power cord	EPVH-20	\$171.00
40 - Foot EDVPV Power Vent System power cord	EPVH-40	\$268.00
60 - Foot EDVPV Power Vent System power cord	EPVH-60	\$364.00
80 - Foot EDVPV Power Vent System power cord	EPVH-80	\$457.00
100 - Foot EDVPV Power Vent System power cord	EPVH-100	\$553.00

NOTE: FOR ARMORED POWERVENT CABLES PLEASE SEE MISCELLANEOUS COMPONENTS SECTION

## C Order the purge control box:

### POST PURGE CONTROL BOXES

Part	Code	List price
Phenom single sided Control Box	ECA045PC	\$673.00
Distinction Control Box	ECA111PV	\$759.00
DelRay Control Box	ECA136PV	\$759.00
Divine and Phenom ST (IPI only) Control Box	ECA062PV	\$673.00

Note: Ordering a control box not required for Exemplar or H36PV

## D Order the speed control box:

### FAN SPEED CONTROL BOXES

Part	Code	List price
Power Vent Fan speed Control Box	PVFCB	\$106.00

## E Order the termination:

### TERMINATIONS

Part	Code	List price
4"/7" Flush Horizontal Termination	TMHIN47-24	\$1,345.00
4"/7" Flush Vertical Termination	TMVIN47-12	\$1,412.00
Stainless steel roof termination, Includes MXT10 adapter [for straight, vertical install]	MVTK1SS	\$280.00
Termination 4/7 Horizontal 4" Length for Power Vent	MTO4-PV	\$480.00
Termination 4/7 Horizontal 4" Length w/ frame for Power Vent	MTO4F-PV	\$522.00
Stainless Termination 4/7 Horizontal 4" for Power Vent †	MTO4SS-PV	\$562.00
Stainless Termination 4/7 Horizontal 4 " w/ frame for Power Vent †	MTO4FSS-PV	\$673.00

## Optional accessories:

### OPTIONAL ACCESSORIES

Part	Code	List price
Power Vent Adjustable Flue Restrictor [for 4"/7" vent system]	MVAFR02	\$59.00

### VENT REDUCER

Part	Code	List price
5"/8" venting to 4"/7" reducer	PVA5487	\$121.00
5"/8" venting to 4"/7" reducing collar [DelRay Square top vent only]	DRSQCOL47	\$160.00
5"/10" venting to 4"/7" reducing collar [Phenom P/PL52 only]	LVA54107	\$214.00

### COMPATIBLE VENTING

Venting
4"/7" Direct Vent Components - Page 35
5"/8" Direct Vent Components - Page 37

# Wall Mount Power Vent - 300

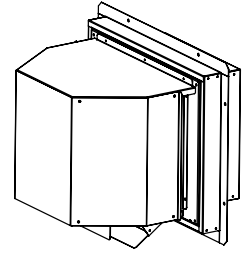

A power vent that re-defines how an external power vent can perform without compromising the aesthetics of your building. This power head uses the best fan technology for years of reliable service. The PVHEX58-300 design minimizes the visual impact by using a side intake - bottom exit to eliminate the previous louvered look. As well, the 300cfm capacity is large enough to handle high BTU residential fireplaces and uses standard 5"/8" or 5"/10" venting. Brushed stainless steel construction assures corrosion free life and a modern look.

**MUST ORDER:** [A Power vent](#), [B Power cord](#)

Compatible with: Exemplar, Exemplar ST,  
RP620, RP424PFC

## A Select the power vent:

### POWER VENT SYSTEM + MOUNTING FRAME

Part	Code	List price
5"/8" Termination [Mounting frame included]	PVHEX58-300	\$3,251.00
5"/10" Termination [Mounting frame included]	PVHEX510-300	\$3,340.00

## Optional accessories:

### COMPATIBLE VENTING

Venting
5"/8" Direct Vent Components - Page 37
5"/10" Direct Vent Components - Page 39

## B Order the power cord:

### EDPV POWER CORDS

Part	Code	List price
10 - Foot EDVPV Power Vent System power cord	EPVH-10	\$122.00
20 - Foot EDVPV Power Vent System power cord	EPVH-20	\$171.00
40 - Foot EDVPV Power Vent System power cord	EPVH-40	\$268.00
60 - Foot EDVPV Power Vent System power cord	EPVH-60	\$364.00
80 - Foot EDVPV Power Vent System power cord	EPVH-80	\$457.00
100 - Foot EDVPV Power Vent System power cord	EPVH-100	\$553.00

NOTE: FOR ARMORED POWERVENT CABLES PLEASE SEE MISCELLANEOUS COMPONENTS SECTION

# Roof Mount Power Vent - 300

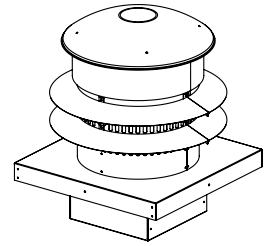

A power vent head that re-defines how an external power vent can perform without compromising the aesthetics of your building. The 300cfm capacity is large enough to handle high BTU residential fireplaces and uses standard 5"/8" or 5"/10" venting. This power head uses the best fan technology for years of reliable service. Brushed stainless steel construction assures corrosion free life and a modern look.

**MUST ORDER:** **A** Power vent, **B** Power cord

Compatible with: Exemplar, Exemplar ST, RP620, RP424PFC

## **A** Select the power vent:

### POWER VENT SYSTEM + MOUNTING FRAME

Part	Code	List price
5"/8" Termination [Mounting frame included]	PVVEX58-300	\$3,583.00
5"/10" Termination [Mounting frame included]	PVVEX510-300	\$3,535.00

## Optional accessories:

### COMPATIBLE VENTING

Venting
5"/8" Direct Vent Components - Page 37
5"/10" Direct Vent Components - Page 39

## **B** Order the power cord:

### EDPV POWER CORDS

Part	Code	List price
10 - Foot EDPV Power Vent System power cord	EPVH-10	\$122.00
20 - Foot EDPV Power Vent System power cord	EPVH-20	\$171.00
40 - Foot EDPV Power Vent System power cord	EPVH-40	\$268.00
60 - Foot EDPV Power Vent System power cord	EPVH-60	\$364.00
80 - Foot EDPV Power Vent System power cord	EPVH-80	\$457.00
100 - Foot EDPV Power Vent System power cord	EPVH-100	\$553.00

NOTE: FOR ARMORED POWERVENT CABLES PLEASE SEE MISCELLANEOUS COMPONENTS SECTION

# Flush Louvered Power Vent - 300

This power head uses the best fan technology for years of reliable service. The PVHFL58-300 design minimizes the visual impact by mounting flush with the side of the building. The 300 cfm capacity is suited for high BTU residential fireplaces and uses standard 5"/8" or 5"/10" venting. Servicing of this product can be performed both from the outside or inside [provided access is available] of the building. This is ideal for multi-unit buildings where the installation may be a distance from the ground. Brushed stainless steel construction assures corrosion free life and a modern look.

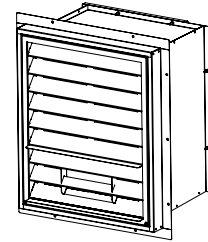

**MUST ORDER:** [A Power vent](#), [B Power cord](#)

Compatible with: Exemplar, Exemplar ST, RP620, RP424PFC

## A Select the power vent:

### POWER VENT SYSTEM + MOUNTING FRAME

Part	Code	List price
5"/8" Termination	PVHFL58-300	\$3,793.00
5"/10" Termination	PVHFL510-300	\$3,793.00

## Optional accessories:

### COMPATIBLE VENTING

Venting
5"/8" Direct Vent Components - Page 37
5"/10" Direct Vent Components - Page 39

## B Order the power cord:

### EDPV POWER CORDS

Part	Code	List price
10 - Foot EDVPV Power Vent System power cord	EPVH-10	\$122.00
20 - Foot EDVPV Power Vent System power cord	EPVH-20	\$171.00
40 - Foot EDVPV Power Vent System power cord	EPVH-40	\$268.00
60 - Foot EDVPV Power Vent System power cord	EPVH-60	\$364.00
80 - Foot EDVPV Power Vent System power cord	EPVH-80	\$457.00
100 - Foot EDVPV Power Vent System power cord	EPVH-100	\$553.00

NOTE: FOR ARMORED POWERVENT CABLES PLEASE SEE MISCELLANEOUS COMPONENTS SECTION



# Flush Louvered Inline Power Vent - 300

When external vents are not permitted, the PVHIN58-300-FS and TMHIN58-40 make the install of residential fireplaces possible. The flush termination allows for installation into combustible materials, concrete or curtain wall materials with ease. The termination is stainless steel for a long corrosion free life. This termination comes complete with the exterior louvers, which can be installed separately once the building construction is completed. The power head contains a 300-series brushless motor design and incorporates a built-in dilution system to allow vent speed reduction for smaller appliances without jeopardizing the motor's operational temperatures.

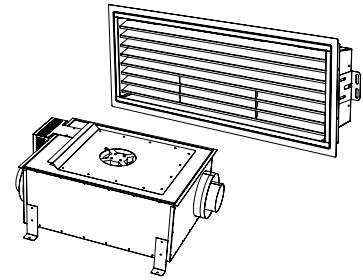

**MUST ORDER:** **A** Power vent, **B** Power cord, **C** Termination

Compatible with: R320, R420, R320-ST, R420-ST, RP620 equipped with Electronic Ignition

## A Select the power vent:

### INLINE POWER VENT

Part	Code	List price
5"/8" Inline Power Vent	PVHIN58-300-FS	\$2,915.00

## B Order the power cord:

### EDPV POWER CORDS

Part	Code	List price
10 - Foot EDVPV Power Vent System power cord	EPVH-10	\$122.00
20 - Foot EDVPV Power Vent System power cord	EPVH-20	\$171.00
40 - Foot EDVPV Power Vent System power cord	EPVH-40	\$268.00
60 - Foot EDVPV Power Vent System power cord	EPVH-60	\$364.00
80 - Foot EDVPV Power Vent System power cord	EPVH-80	\$457.00
100 - Foot EDVPV Power Vent System power cord	EPVH-100	\$553.00

NOTE: FOR ARMORED POWERVENT CABLES PLEASE SEE MISCELLANEOUS COMPONENTS SECTION

## C Order the termination:

### TERMINATIONS NOTE: FOR INLINE POWERVENTS ONLY

Part	Code	List price
5"/8" Flush Termination	TMHIN58-40	\$1,732.00
Termination 5/8 Horizontal 4" Length for Power Vent	PTO4-PV	\$480.00
Termination 5/8 Horizontal 4" Length w/ frame for Power Vent	PTO4F-PV	\$522.00
Stainless Termination 5/8 Horizontal 4" for Power Vent †	PTO4SS-PV	\$297.00
Stainless Termination 5/8 Horizontal 4" w/ frame for Power Vent †	PTO4FSS-PV	\$601.00

## Optional accessories:

### COMPATIBLE VENTING

Venting
4"/7" Direct Vent Components - Page 35
5"/8" Direct Vent Components - Page 37



# Designer Burner Accessories

**Decorative media:**



## Stones, Glass & Beads

**GLOWING NEON EMBERS**  
RNEMBERS



**FIREGLASS**

Part	Code	List price
Obsidian	HW1113	\$53.00
Platinum	HW1144	\$53.00
Ice	HW1157	\$31.00
Copper	HW1143	\$53.00

**COPPER**  
HW1143

**PLATINUM**  
HW1144

**FIRESTONES**

Part	Code	List price
Amber	HW1261	\$63.00
Glacier	HW1219B	\$63.00
Alabaster	HW1260	\$63.00
Onyx	HW1259	\$63.00

**OBSIDIAN**  
HW1113

**FIBER EMBERS**  
REMBERS



**FIREBEADS**

Part	Code	List price
Frost	HW1112	\$22.00
Quartz	HW1106	\$22.00
Ebony	HW1091	\$22.00

**EMBERS**

Part	Code	List price
Glowing Neon Embers - [2g bag]	RNEMBERS	\$13.00
Fiber Embers - [10g bag]	REMBERS	\$54.00

1 order is for one (1) 3lb bag of glass.  
All linear models supplied with firestones or fireglass, cost is for additional order.  
[Excluding the 30FID\*I-L or 34FID\*I-L]

# Miscellaneous Components

## SILICONE

Part	Code	List price
Milpack Black High Temperature Sealant	IN2013	\$56.00

## GAS CONNECTORS

Part	Code	List price
Flex Gas Connector 1/2" shut off to 3/8" - 12" length	RGF1038	\$38.00
Flex Gas Connector 1/2" shut off to 3/8" - 24" length	RGF1039	\$57.00

## TOUCH UP PAINT

Part	Code	List price
Satin Black - 12oz	Paint01HT	\$46.00

## HOME AUTOMATION

Part	Code	List price
Smart Home Automation Fireplace Control	HAFC	\$223.00

## GLASS CLEANER

Part	Code	List price
White Off Glass Cleaner	RT565	\$37.00

## ARMORED POWERVENT CABLES

Part	Code	List price
10' Armored EDVPV Power Vent power cord	EPVHA-10	\$202.00
20' Armored EDVPV Power Vent power cord	EPVHA-20	\$315.00
40' Armored EDVPV Power Vent power cord	EPVHA-40	\$522.00
60' Armored EDVPV Power Vent power cord	EPVHA-60	\$722.00
80' Armored EDVPV Power Vent power cord	EPVHA-80	\$1,000.00
100' Armored EDVPV Power Vent power cord	EPVHA-100	\$1,200.00

NOTE: Montigo recommends all commercial or multi dwelling applications use armored powervent cable. Please check local code.

## BOARD ANTENNA

Part	Code	List price
Proflame 2 Board Antenna	REC1491	\$44.00